

# PHOTOPHONE 450

## Amplified Big Button Telephone With Photo Dial

The Photophone 450 has been developed in partnership with:

**ACTION ON**  
**HEARING**  
**LOSS**



**English**

# SETTINGS

!!!Please refer to our website: [www.geemarc.com](http://www.geemarc.com) for an up to date user guide, as there may be important updates and changes you need to be aware of !!!

<b>CONTENTS</b> .....	<b>1</b>
<b>INTRODUCTION</b> .....	<b>3</b>
Unpacking the Telephone.....	4
<b>DESCRIPTION</b> .....	<b>5</b>
General Description.....	5
Key Description .....	7
LCD Description .....	7
<b>INSTALLATION</b> .....	<b>8</b>
Setting Up.....	8
Wall Mounting.....	8
Table Mounting.....	10
<b>SETTINGS</b> .....	<b>11</b>
Set Language .....	11
Set LCD Contrast .....	11
Set Date and Time.....	12
Set Flash Time .....	12
Set Service Access.....	13
Set Tone (Dialling Mode).....	13
Set Ringer Volume .....	14
Set Ringer Tone .....	14
Receiving Volume .....	14
Handset Volume Boost Button.....	14
<b>USING THE TELEPHONE</b> .....	<b>16</b>
Making a Call.....	16
Last Number Redial.....	17
Dialling a Number from the Redial List .....	17
Call Timer .....	17

# CONTENTS

Receiving a Call.....	17
Hearing Aid Use .....	17
<b>OPTIONAL ACCESSORIES .....</b>	<b>18</b>
Flash Signal.....	18
Headset .....	18
<b>CALLER ID .....</b>	<b>19</b>
View Caller ID List .....	19
Dial a Number from the Caller ID List.....	19
Add a Number from the Caller ID List to the Phone Book .....	20
Delete a Number from the Caller ID List.....	20
Delete all Numbers from the Caller ID List.....	20
Caller ID on Call Waiting .....	20
<b>PHONE BOOK .....</b>	<b>21</b>
Create a Phone Book Entry .....	21
View Phone Book Entries .....	22
Dial a Phone Book Entry .....	22
Modify a Phone Book Entry .....	23
Delete a Phone Book Entry .....	24
Delete all Phone Book Entries.....	24
<b>PHOTO DIAL .....</b>	<b>25</b>
Create a Photo Dial Number.....	25
View/Dial a Photo Dial Number .....	25
Clear a Photo Dial Number.....	25
<b>SERVICE ACCESS.....</b>	<b>26</b>
Calling a Service Number .....	26
<b>TROUBLESHOOTING .....</b>	<b>27</b>
<b>SAFETY INFORMATION .....</b>	<b>28</b>
<b>GUARANTEE.....</b>	<b>29</b>
<b>RECYCLING DIRECTIVES .....</b>	<b>30</b>

# INTRODUCTION

Congratulations on purchasing your Geemarc PHOTOPHONE 450 which has been developed in conjunction with Action on Hearing Loss in the UK. This is a multifunction telephone which offers features such as hands free use, caller ID\* and a phone book. It offers handset amplification and a loud ringer, helpful for those with hearing loss. It has large buttons, and an easy to see and use keypad to help stop any misdialling. It has photo dial buttons designed to make dialling easier you will be able to identify speed dial buttons with pictures of your family and friends. This telephone is also compatible with hearing aids.

Since this telephone has handset amplification, it is capable of producing loud volume levels.

It is important that you read the instructions below in order to use your Geemarc telephone to its full potential. Keep this user guide in a safe place for future reference.

This guide explains how to use the **PHOTOPHONE 450**



# INTRODUCTION

## Unpacking the Telephone

---

When unpacking the telephone, you will find the following in the box:

- 1 PHOTOPHONE 450
- 1 PHOTOPHONE 450 handset with curly cord
- 1 Telephone line cord
- 1 Mains power adaptor
- 1 User Guide



For product support and help visit our website at

**[www.geemarc.com](http://www.geemarc.com)**

telephone **01707 387602**

or fax **01707 832529**

# DESCRIPTION

## General Description

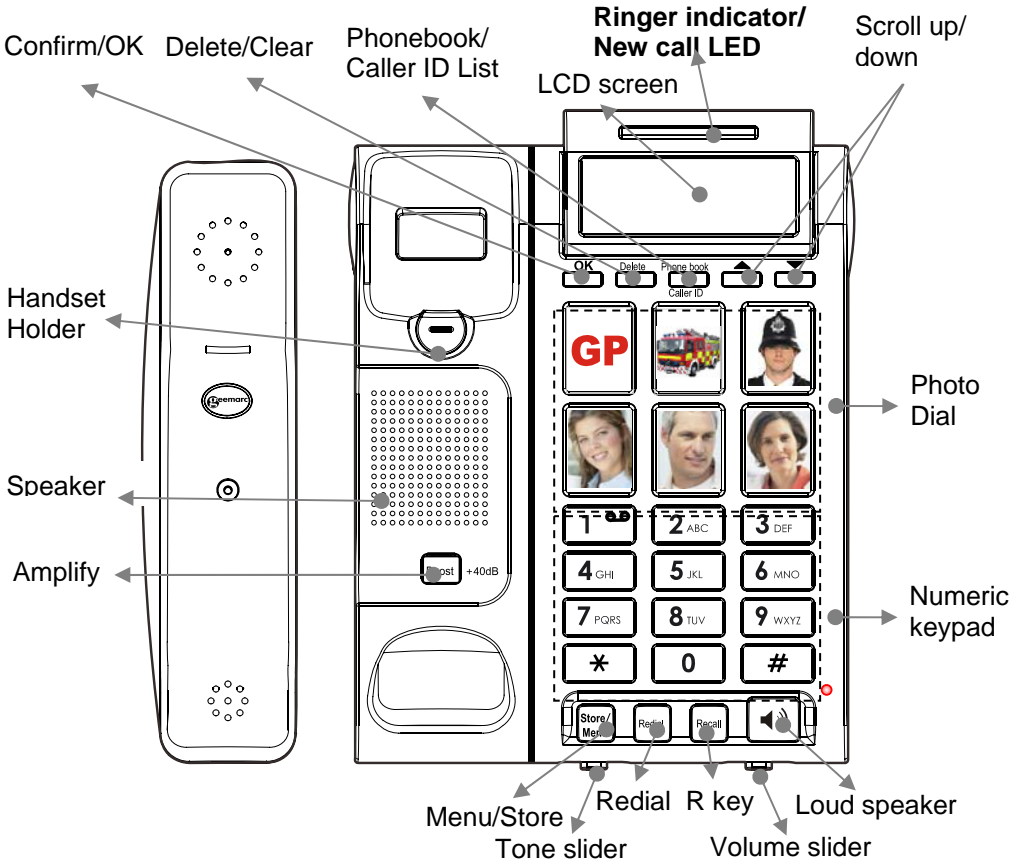



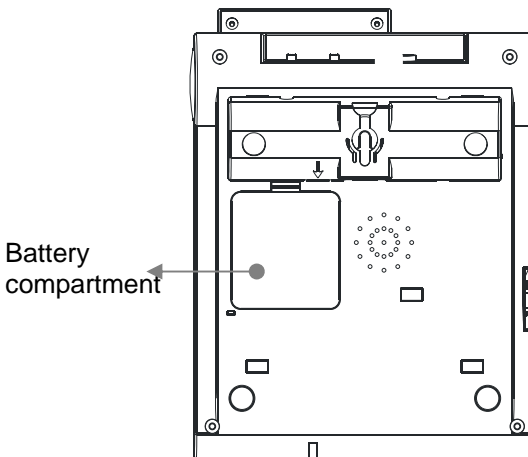
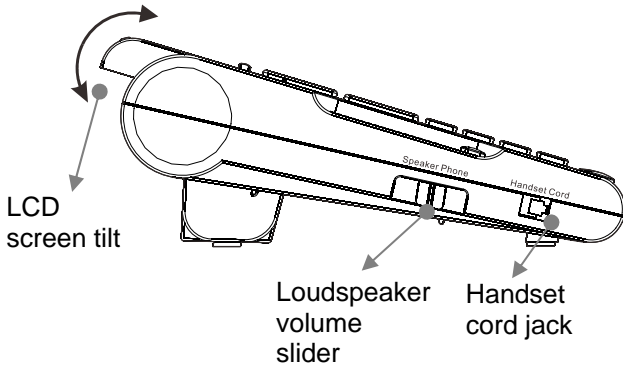
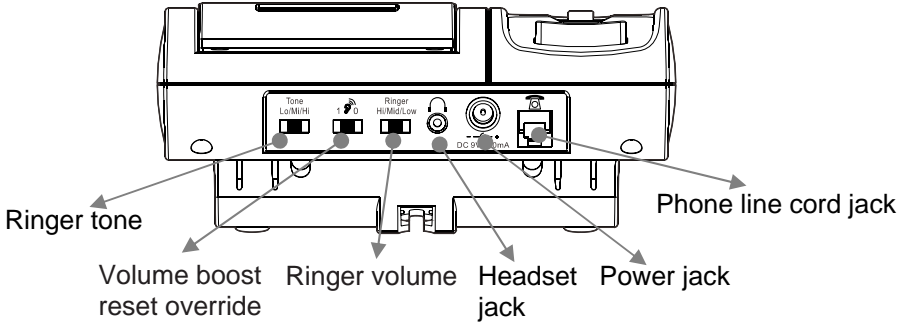

# DESCRIPTION



# DESCRIPTION

## Key Description

<b>Store/Menu</b>	Enter the change settings menu. Store numbers to memory.
<b>Redial</b>	Last number redial. Insert a pause when pre-dialing a number.
<b>Recall</b>	This button is used to disconnect a call and re-establish dial tone or to switch over to another caller provided you have requested these services i.e. call waiting from your service provider.
	Make/Answer/End a call. Activates the speakerphone if pressed during a call.
	Confirm Setting/Make Call.
<b>Delete</b>	Delete incorrect digits or characters. Delete an entry in Phone Book or Caller ID List.
<b>Phone book / Caller ID</b>	Toggle between Caller ID list and Phone book
 and 	Scroll through the menu options. Move through a number or name when in edit mode. Enter the Caller ID list
<b>Boost (+40dB)</b>	Press this button to switch the handset amplification ON or OFF.

## LCD Description

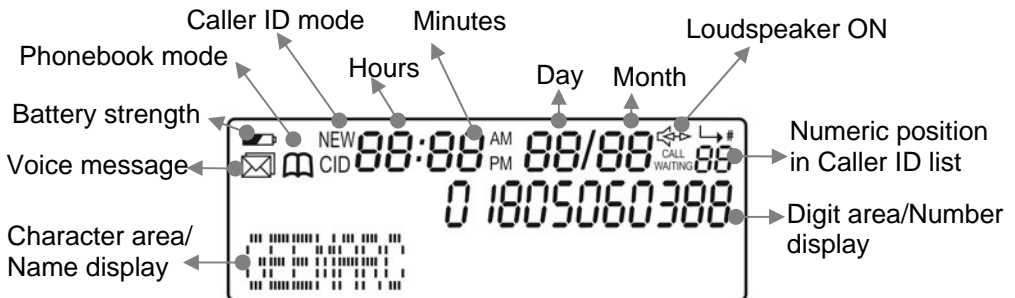

In standby mode, the large LCD display will show as below

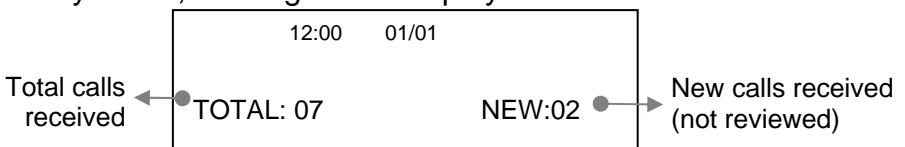



# INSTALLATION

## Setting Up

---

The telephone requires four good quality non-rechargeable AAA batteries. These are not supplied with your telephone. Carefully remove the battery compartment cover found on the underside of the telephone base. We suggest using the tip of a ball point pen to open the cover. Check the battery polarity diagrams when inserting the batteries. Fit the battery cover back on.

Connect one end of the curly cord to the handset. The other end of the curly cord plugs into the jack on the left hand side of the PHOTOPHONE 450 unit marked **Handset Cord**. Place the handset on the cradle.

Connect the line cord to the socket located at rear of telephone then connect the plug into the wall socket\*\*.

For the LCD display, backlight and other special features you must use the power adapter (batteries act as a backup in case of power failure). Connect the power adaptor to the jack located at the rear of the telephone marked DC9V then plug the other end into a 13amp mains power wall socket (\*). Please choose a socket near your telephone to enable you to unplug the mains power quickly in case of a problem.

(\*) Classified “hazardous voltage” according to EN60950 standard

(\*\*) Classified TNV-3 according to EN60950 standard.

## Wall Mounting

---

Rotate the handset hanger tab 180 degrees (see diagram 1). This will keep the handset from falling out of the cradle when it is mounted on the wall.

Knock two self-tapping screws (not supplied) into a wall at a distance of 85 mm from each other and placed in a vertical line. Leave the screws protruding from the wall by 6mm (see diagram 2).

Feed the guide tabs on the wall-mounting bracket into the slots at the bottom of the telephone. Slide the bracket upwards until it

# INSTALLATION

snaps into place. Now place the telephone over the screws and push it downwards (slightly).

Place the phone onto the screw-heads and slide down to secure.

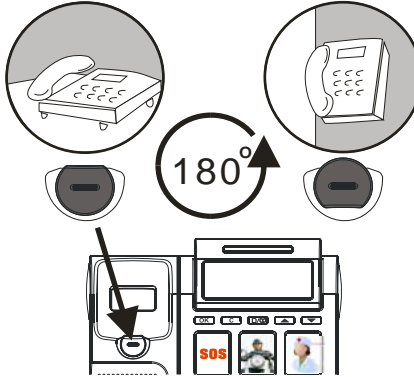

Diagram 1

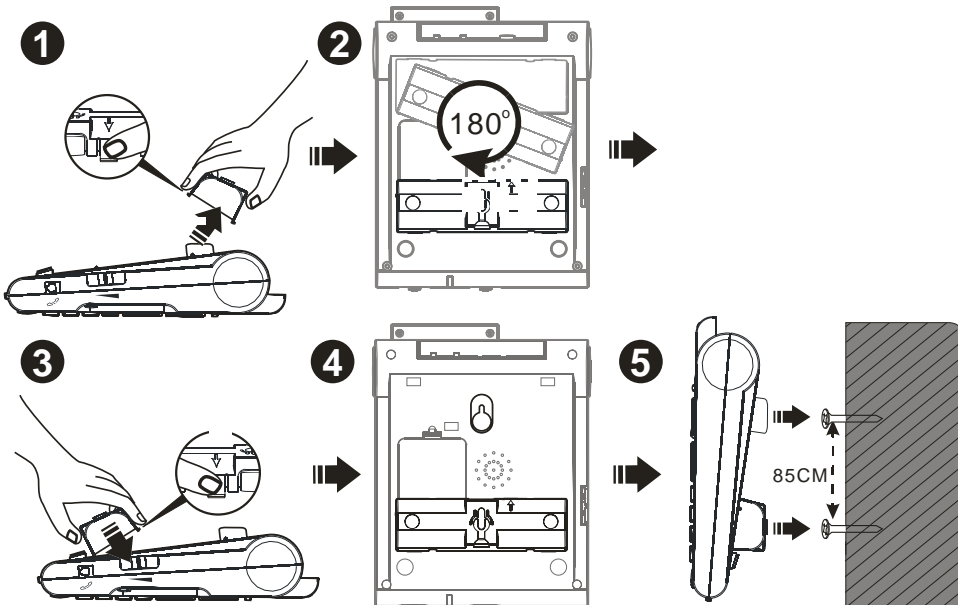

Diagram 2

# INSTALLATION

## Table Mounting

---

When using the wall mounted bracket with the telephone mounted on a table, it allows better access to the keypad.

Feed the guide tabs on the wall-mounting bracket into the slots at the top of the telephone and place on a table. See diagram below.

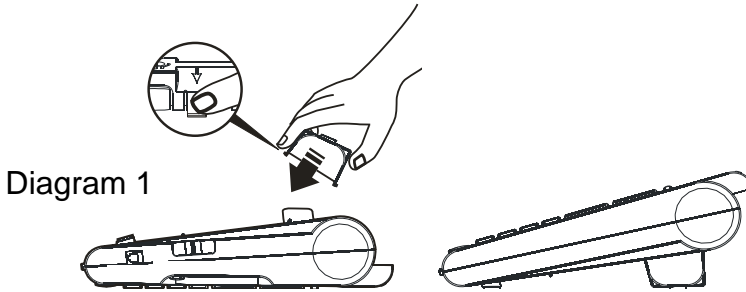
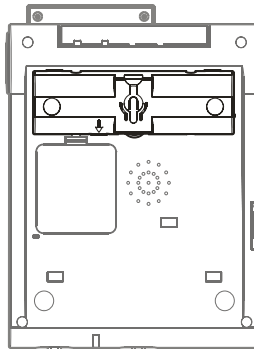

Diagram 2



# SETTINGS

Once you have plugged the Photophone450 into the mains, the default language will flash on the LCD screen. This will be 'ENGLISH'. If this is not displayed, press **Store/Menu** to enter the settings change menu.

## Set Language

Use ▲ and ▼ to select another language. There are 6 languages to choose from.

Press **OK** button to save and move onto the next setting

## Set LCD Contrast

Your screen has a backlight which automatically switches off after 15 seconds of inactivity. The contrast of the backlight against the text can be increased or decreased.

'LCD CONTRAST' will be displayed on the screen. The current setting will flash. '2' is the default contrast level.

Use ▲ and ▼ to select 1 of the 4 contrast levels available.

Press **OK** button to save and move onto the next setting

# SETTINGS

## Set Date and Time

---

In standby mode, the telephone displays the current date and time. You need to set the date and time so that when you receive calls they will appear in the call list with the correct date and time. If you subscribe to a Caller ID service, the time and date will be set automatically when you receive your first call.

'**SET TIME/DATE**' will be displayed on the screen. The hour digits will flash.

Use ▲ and ▼ to enter the correct hour (24 hour clock)

Press **OK** button to save

The minute digits will flash

Use ▲ and ▼ to enter the correct minutes

Press **OK** button to save

The date digits will flash

Use ▲ and ▼ to enter the correct date (1-31)

Press **OK** button to save

The month digits will flash

Use ▲ and ▼ to enter the correct month (1-12)

Press **OK** button to save and move onto the next setting

## Set Flash Time

---

You can adjust the flash time setting. There are three options available. Your telephone works with a flash time for United Kingdom (R=100ms).

'**FLASH TIME**' will be displayed on the screen and the current selected flash time will be flashing.

Use ▲ and ▼ to select 100

Press **OK** button to save and move onto the next setting

# SETTINGS

## Set Service Access

You can select keys 1 and/or 2 on the numeric keypad to store service access telephone numbers e.g. 1571 for British Telecom's answering machine service.

**'SERVICE ACCESS'** will be displayed on the screen.

Press **OK** button to save and move onto the next setting

**'KEY 1, 2'** will be displayed on the screen.

Use **▲** and **▼** to select the key you wish to store the service access number on

Press **OK** button

The number cursor will start to flash, enter the number you wish using the numeric keypad.

Press **OK** button

The name cursor will start to flash at the bottom of the LCD display

Enter the name you wish to associate with the number using the numeric keypad. See Phone Book chapter on using the numeric keypad to enter characters

Press **OK** button **'SAVED'** will be displayed

## Set Tone (Dialling Mode)

In the UK telephone exchanges use Tone dialing, and also for interactive services. However, if your telephone does not dial out, it is probably being used from an older private switch box (PBX). In this case select the Pulse setting.

**'TONE'** will be displayed on the screen.

Use **▲** and **▼** to select either **'TONE'** or **'PULSE'**.

Press **OK** button to save and move onto the next setting

# SETTINGS

## Set Ringer Volume

---

The ringer volume switch is found at the rear of the telephone. You can select one of 3 volume settings: **Lo / Mid / Hi** .

It is not possible to switch the ringer off, but it can be set to low volume by selecting the Lo setting.

## Set Ringer Tone

---

The ringer tone switch is found at the rear of the telephone. You can select one of 3 tone settings: **Low / Mid / Hi** .

The Hi setting produces a high-pitched ringer sound.

The Lo setting produces a low-pitched ringer sound.

## Receiving Volume

---

You can alter the receiving volume during a conversation according to your hearing requirements.

Use the Volume slider control found at the front of the telephone base to adjust the volume level in the handset.

## Handset Volume Boost Button

---

The **Boost** button on the telephone base (below the speaker) provides additional handset amplification of up to 20dB i.e the volume adjustment available is 20-40dB. When the amplify function is activated, the LED on the Boost button is lit (red).

With the boost off the volume adjustment available is 0-20dB.

The maximum amount of amplification available is up to 40dB. This is with the handset volume set to maximum, and with the amplify switched on.



**CAUTION:** This telephone is capable of producing loud volume levels.

## Receiving Tone Settings

You can alter the receiving tone during a conversation according to your hearing requirements.



# SETTINGS

Use the tone slide control found at the front of the telephone to adjust the tone in the handset\*

The tone control can be used to increase the high (treble) frequencies and the low (base) frequencies.



\* The tone control only has an affect when the amplify function is activated (red LED on the boost button is lit)

## Setting a default for Amplification.



The  located at the rear allows the amplification facility to be switched **ON** (1) or **OFF** (0) as a default each time you use the telephone.

### AMPLIFY ON/OFF Switch at ON (1) Position

The handset amplify function and tone control are automatically activated each time you pick up the handset. The LED on the boost button will be lit when you use the telephone.

### AMPLIFY ON/OFF Switch at OFF (0) Position

The additional amplification and tone controls are turned off each time you use the telephone. The Amplify LED will be off whenever you use the telephone.

Pressing the  button once during a call will enable tone control and additional amplification. The LED light will turn on to reflect this change. If you press the  button once more, the additional amplification and tone control features will be turned off once again. The LED light will turn off to reflect this change.

Irrespective of how many times you press the  key throughout a call, the next time you pick up the handset, these functions will be turned off once again.



# USING THE TELEPHONE





## Making a Call

Pick up the handset.

When you hear the dialling tone, dial the number on the keypad.



To end the call simply replace the handset in the cradle

## Making a Call – Hands Free (speakerphone)

Press the  button to hear the dialling tone then dial the telephone number on the keypad. The  icon appears on the LCD. To end the call, simply press  again. The  icon will disappear.

To activate the Hands Free function during the call, press the  button and replace the handset on the cradle at the same time.

To deactivate the Hands Free function during a call, lift the handset.

When in handset mode changed to hands free, press  more than 3 seconds the, The  icon will disappear.

**Note:** When in hands free mode, only one person may talk at a time. The switch-over between speaker and microphone is automatic. This is dependent on the sound level of the incoming call and the microphone respectively. It is therefore essential that there are no loud noises, e.g. music, in the immediate vicinity of the telephone, as this will disrupt the hands free function.

## Speakerphone Volume Setting

You can adjust the speakerphone volume by using the volume slider control labelled **Speaker Phone** - located on the left side of the telephone base.

## Pre-Dialling a Telephone Number

You can enter the desired phone number in standby mode, which allows you to make corrections before dialling. Follow these steps:

Enter a telephone number (up to 22 digits). Check it. If you make a mistake while entering a number, press the **DELETE** button to edit it.

When the number appears correctly, lift the handset, press **OK** or press the  button.

# USING THE TELEPHONE

## Last Number Redial

Lift the handset or press  for hands free use

Press **Redial** to redial the last number dialled.

## Dialling a Number from the Redial List

Press **Redial** repeatedly whilst in standby mode to scroll through the redial list of 5 telephone numbers to find the desired number

Lift the handset, press **OK** or press  for hands free use

## Call Timer

Once you dial a telephone number and for a short time after the call is finished, a call timer will be shown on the display. The timer is a simple way to help you keep track of how long a call lasts.

## Receiving a Call

When an incoming call is received, the telephone rings and the incoming call red LED lights up.

Lift the handset and speak

To end the call simply replace the handset in the cradle

## Receiving a call – Hands Free

Press  to speak hands free

To end the call press 

## Hearing Aid Use

This telephone is hearing aid compatible. You will need to select the T / loop setting on your hearing aid to use this feature. You may need to adjust the positioning of the handset earpiece in relation to your hearing aid to get the best results. You may also find that you need to increase the handset volume slider to get a comfortable volume level through your hearing aid, but always start off at a low volume (with the amplify feature boost button switched off) and the gradually increase the handset volume slider.

It is unlikely that you will need to have the handset amplify / boost button switched on when using a hearing aid.

# OPTIONAL ACCESSORIES

## Flash Signal

---

The **Recall** button can be used with special services such as Call Waiting (if provided by your service provider) e.g. when a call waiting signal is heard, press **Recall** and await the dialling tone, then press **2** to transfer to the other caller. Or the **Recall** button can transfer external calls to another extension within a private switchboard. Simply press **Recall** followed by the required extension number.

## Hands free (Headset)

---

Your phone has a headset jack. This allows you to listen and speak through a headset.



Connect the headset at the rear side of the telephone in the 2.5mm jack socket labelled as .

# CALLER ID

The features described in this section onwards is only available if you subscribe to a Caller ID service from your network provider.

Caller ID means you can see who is calling on your handset display (provided the number is not withheld, unavailable or is an international call). If the telephone number is stored in the Phonebook, the callers name will be displayed together with their telephone number.

The display shows '**PRIVATE**' for a withheld number.

The display shows '**UNAVAILABLE**' when someone calls from an area where the telephone company is not offering caller identification services or is not yet providing number delivery to your area.

Whether you take a call or not, the caller's telephone number/name together with the date and time of the call are stored in the Caller ID list. This list stores the last 50 incoming calls. Received calls are stored chronologically with the sequential number shown in the top right hand corner of the LCD display. When the Caller ID list is full, the oldest number will be deleted automatically as the new call is logged.

The green new call LED will flash to notify you of a new call and '**NEW**' call count will be increased by 1.

If you receive a call from a number that is stored in one of the six photo dial buttons, this button will flash bright red and if unanswered will flash for 1 minute.

## View Caller ID List

Use ▲ and ▼ to scroll through the Caller ID list. The numbers will be listed in the order they were received. Scrolling through this list in order to review any new calls sets the New Call count to zero and the New Call LED will be switched off

## Dial a Number from the Caller ID List

Use ▲ and ▼ to scroll through the Caller ID list until you find the desired number

Press OK or press  for hands free use. If you wish to use the handset, pick it up once the number is being dialled

# CALLER ID

## Add a Number from the Caller ID List to the Phone Book

Use ▲ and ▼ to scroll through the Caller ID list until you find the number you wish to add to the phone book

Press and hold **store/Menu** until '**COPY NUMBER?**' is displayed

Press and hold **Store/Menu** again

'**SAVED**' will be displayed

**Note:** If you wish to add a name to be associated with the telephone number see section – Modify a Phone Book Entry.

## Delete a Number from the Caller ID List

Use ▲ and ▼ to scroll through the Caller ID list until you find the **number** you wish to delete from the Caller ID list

Press **Delete** button. '**DELETE?**' will be displayed

Press and hold **Delete** for two seconds until the number has been deleted

## Delete All Numbers from the Caller ID List

Use ▲ and ▼ to enter the Caller ID list

Press and hold **Delete** button. '**DELETE ALL?**' will be displayed

Press and hold **Delete** again until all the numbers have been deleted. '**NO CALL**' will be displayed

By deleting all the entries in the Caller ID list, the Total Call count will be set to zero

## Caller ID on Call Waiting

When you are using the telephone, if you have subscribed to Call Waiting with your service provider, the number (and name if stored in Phonebook) of a second caller will be displayed together with a message saying '**CALL WAITING**'.

Press the **Recall** key and '**2**' to answer the second caller. When you have finished with the second caller, press **Recall** and '**2**' again to resume conversation with the original caller.

# PHONE BOOK

Telephone numbers can be stored in the phone book. It allows you to store frequently used numbers so that you can easily make a call without having to remember or enter the telephone number.

The phone book can contain 50 entries. Each phone number can contain up to 22 digits and the associated name can have 16 characters.

**Note:** If you require the phone book, it is only available when in Phone Book mode (☎ icon on). If the Caller ID icon is on (CID), press **Phone book/Caller ID** until the ☎ icon is displayed.

## Create a Phone Book Entry

Press **Phone book/Caller ID** button until the ☎ icon is displayed

'TOTAL: X' will be displayed showing the number of entries stored in the Phone Book

Press and hold **Store/Menu** 'SAVE?' will be displayed

Press **Store/Menu**. The number cursor will start to flash

Enter the number you wish using the numeric keypad (up to 22 digits)

Press **Store/Menu**. The name cursor will start to flash at the bottom of the LCD display

Enter the name you wish to associate with the number using the numeric keypad (up to 16 characters). See below on using numeric keypad to enter characters

Press **Store/Menu** 'SAVED' will be displayed

**Note:** If you make a mistake while entering a name or number, press the **DELETE** button to clear the last character/digit and then enter the correct character/digit.

## Insert Pause

Inserting a pause provides a delay of 3 seconds. This is necessary with some telephone systems.

To insert a dialling pause between numbers when storing a number, press **Redial** button until 'P' appears in the LCD display.

# PHONE BOOK

## Character Map

1.....	[Space character] + & - / X 1
2.....	A B C Å Ä Æ æ å ä ß 2
3.....	D E F ë 3
4.....	G H I İ 4
5.....	J K L 5
6.....	M N O Ñ ñ Ö ö 6
7.....	P Q R S 7
8.....	T U V Ü ü 8
9.....	W X Y Z 9
* .....	' @ ( ) * < >
0.....	, . : ? = 0
#.....	\$ _ % ! #

If you need to enter the same letter twice or another letter with the same key, wait a few seconds and the cursor will move automatically to the next space.

## View Phone Book Entries

Press **Phone book/Caller ID** button until the  icon is displayed

'**TOTAL: X**' will be displayed showing the number of entries stored in the Phone Book

Use **▲** and **▼** to scroll through the phone book until you find the contact you wish to view

## Dial a Phone Book Entry

Press **Phone book/Caller ID** button until the  icon is displayed

'**TOTAL: X**' will be displayed showing the number of entries stored in the Phone Book

Use **▲** and **▼** to scroll through the phone book until you find the contact you wish to dial

Press **OK** or press  for hands free use. If you wish to use the handset, pick it up once the number is being dialled

# PHONE BOOK

## Modify a Phone Book Entry

Press **Phone book/Caller ID** button until the  icon is displayed

**'TOTAL: X'** will be displayed showing the number of entries stored in the Phone Book

Use **▲** and **▼** to scroll through the phone book until you find the contact you wish to edit

Press and hold **Store/Menu** **'EDIT?'** will be displayed

Press and hold **Store/Menu** again. The number cursor will start to flash

Use **▲** and **▼** to navigate to the digit(s) you wish to edit. Use **DELETE** to delete incorrect digits and enter the new digits required using the numeric keypad

Press **Store/Menu**. The name cursor will start to flash at the bottom of the LCD display

Use **▲** and **▼** to navigate to the character(s) you wish to edit. Use **DELETE** to delete incorrect characters and enter the new characters required using the numeric keypad

Press **Store/Menu** **'SAVED'** will be displayed



# PHONE BOOK

## Delete a Phone Book Entry

Press **Phone book/Caller ID** button until the  icon is displayed

'**TOTAL: X**' will be displayed showing the number of entries stored in the Phone Book

Use **▲** and **▼** to scroll through the phone book until you find the contact you wish to delete

Press **DELETE** button. '**DELETE?**' will be displayed

Press and hold **DELETE** until the number has been deleted

## Delete all Phone Book Entries

Press **Phone book/Caller ID** button until the  icon is displayed

'**TOTAL: X**' will be displayed showing the number of entries stored in the Phone Book

Use **▲** and **▼** to enter the phone book

Press and hold **Delete** button. '**DELETE ALL?**' will be displayed

Press and hold **Delete** again until all entries have been deleted. '**EMPTY**' will be displayed

By deleting all the numbers in the Phone book, the Total Entry count for the Phone book will be set to zero.

# PHOTO DIAL

This telephone has 6 photo dial memory buttons. You can store your contact's photograph under the perspex of the button. This is very useful if you tend to forget telephone numbers or names.

## Create a Photo Dial Number

Press and hold **Store/Menu** until '**STORE NUMBER**' is displayed and the number cursor flashes

Enter the telephone number to be stored (maximum of 22 digits). You can edit the number using the **Delete** button

Press **Store/Menu**. The name cursor will flash

Enter the name to be stored (maximum of 16 characters – See Phone Book chapter on using the numeric keypad to enter characters). You can edit the name using the **Delete** button

Press **Store/Menu**. '**LOCATION?**' will be displayed

Press Photo1-Photo6 to store the photo dial number

## View/Dial a Photo Dial Number

In standby mode, press the required photo dial location. The telephone number will be displayed

Lift the handset, press **OK** or press  for hands free use to dial the photo dial telephone number

## Clear a Photo Dial Number

Store a new telephone number on a previously used photo dial location – this will overwrite the name and number stored.

# SERVICE ACCESS

## Calling a Service Number

---

If a BT service access telephone number has been stored (see Settings – Set Service Access Number) e.g. BT's 1571 service, this service access number can be called with the press of just one key.

Press and hold '**1**' or '**2**' for 2 seconds until the service access number is displayed on the LCD screen.

Press **OK** to dial the number. If you need to dial a telephone number at this point, you can use the numeric keypad.

# TROUBLESHOOTING

## **No display**

- Make sure that the power adaptor is plugged in correctly and is not damaged.
- Check for a power cut in the area.

## **PHOTOPHONE 450 does not ring**

- Make sure that the telephone line cord is plugged in correctly and is not damaged.
- Connect another telephone to the telephone socket or move your telephone to another socket to track if the failure is coming from your telephone or your socket.
- There may be too many communication devices connected to a single telephone line e.g. another telephone, modem or facsimile machine. Contact your network provider for help in calculating the limit for your home or business line .
- [There is no ringer off setting on this phone]
- Check the Volume level of the ringer.

## **No dial tone**

- Make sure that the telephone line cord is plugged in correctly and is not damaged.
- Connect another telephone to the telephone socket or move your telephone to another socket to check if the failure is coming from your telephone line.
- There may be too many communication devices connected to a single telephone line e.g. another telephone, modem or facsimile machine. Contact your network provider for help in calculating the limit for your home or business line.
- Check that the dialing mode is set to the correct setting (tone or pulse).

## **Interference on the line**

- Ensure a filter is fitted to all telephone sockets if you have a DSL line / broadband internet access set up on your phone line.

## **No Caller ID information displayed**

- Ensure you have requested the Caller ID service from your network provider.

## **No Amplification**

- Check the Amplify feature is switched on and that the LED next to the boost button is lit red).

# SAFETY INFORMATION

## General

Only use the power supply that is included with this product.

Do not open the unit. Contact the helpline or your retailer for all repairs.

## Hearing damage

The phone is capable of amplifying sounds to a loud volume. It is important to instruct all potential users of its proper operation. It is advised to adjust the volume control to its minimum level (Low) and then gradually increase the volume to a comfortable level if needed. Alert other users that hearing damage can potentially result from misuse.

## Cleaning

Clean the telephone with a soft cloth. Never use polishes or cleaning agents - they could damage the finish or the electrics inside.

## Environmental

Do not expose to direct sunlight.

Always ensure there is a free flow of air over the surfaces of the telephone.

Do not place any part of your product in water and do not use it in damp or humid conditions e.g. bathrooms.

Do not expose your product to fire or other hazardous conditions.

Unplug your phone from the telephone socket during thunderstorms because it could damage your telephone. Your guarantee does not cover thunderstorm damage.

The telephone is designed for working within a temperature range of 5°C to 45°C.

# GUARANTEE

From the moment your Geemarc product is purchased, Geemarc guarantee it for the period of two years. During this time, all repairs or replacements (at our discretion) are free of charge. Should you experience a problem then contact our help line or visit our website at [www.geemarc.com](http://www.geemarc.com). The guarantee does not cover accidents, negligence or breakages to any parts. The product must not be tampered with or taken apart by anyone who is not an authorized Geemarc representative. The Geemarc guarantee in no way limits your legal rights.

**IMPORTANT:** YOUR RECEIPT IS PART OF YOUR GUARANTEE AND MUST BE RETAINED AND PRODUCED IN THE EVENT OF A WARRANTY CLAIM.

Please note: The guarantee applies to the United Kingdom only

**DECLARATION:** Geemarc Telecom SA hereby declares that this product is in compliance with the essential requirements and other relevant provisions of the Radio and Telecommunications Terminal Equipment Directive 2014/53/UE and in particular article 3 section 1a, 1b and section 2. The telephone does not operate if the line current is lower than 18 mA.

*The declaration of conformity may be consulted at [www.geemarc.com](http://www.geemarc.com)*



**Electrical connection:** The apparatus is designed to operate from a 230V 50Hz supply only. (Classified as 'hazardous voltage' according to EN60950 standard). The apparatus does not incorporate an integral power on/off switch. To disconnect the power, either switch off supply at the mains power socket or unplug the AC adaptor. When installing the apparatus, ensure that the mains power socket is readily accessible.

**Telephone connection:** Voltages present on the telecommunication network are classified TNV-3 (Telecommunication Network Voltage) according to the EN60950 standard.

# RECYCLING DIRECTIVES

The WEEE (Waste Electrical and Electronic Equipment) has been put in place for the products at the end of their useful life are recycled in the best way.

When this product is finished with, please do not put it in your domestic waste bin.

Please use one of the following disposal options:

- Remove the batteries and deposit them in an appropriate WEEE skip. Deposit the product in an appropriate WEEE skip.
- Or, hand the old product to the retailer. If you purchase a new one, they should accept it.

Thus if you respect these instructions you ensure human health and environmental protection.



For product support and help visit our website at

**[www.geemarc.com](http://www.geemarc.com)**

telephone **01707 387602**

or fax **01707 832529**



UGPHOTOPHONE450 \_En\_v1.1

**geemarc™ UNITED KINGDOM**  
Telecom SA

5B Swallow Court  
Swallowfields  
Welwyn Garden City  
Hertfordshire, AL7 1SB  
For product support:  
01707 387602

[www.geemarc.com](http://www.geemarc.com)