



# Prisma

USER MANUAL



NTSC VERSION

# Table of Contents

Package Contents .....	2
Installation .....	3
Controls .....	4
Power .....	4
Lights .....	4
Mode .....	4
Magnification .....	4
Focus .....	5
Brightness Control .....	5
Using the Prisma .....	6
Reading with the Prisma .....	6
Writing .....	7
Hints and Tips .....	7
Taking Care of your Prisma .....	8
Specifications .....	9
Declaration of Conformity .....	9
Warranty .....	10

## Package Contents

Your Prisma package should contain the following items:

- Prisma camera and table
- Power supply transformer
- Output cable
- Reading mat
- User's manual
- Allen key for adjusting the hinge tension
- Carry case with internal padding

**Please retain the packaging in case there is a need to return the unit for service or repair.**

# Installation

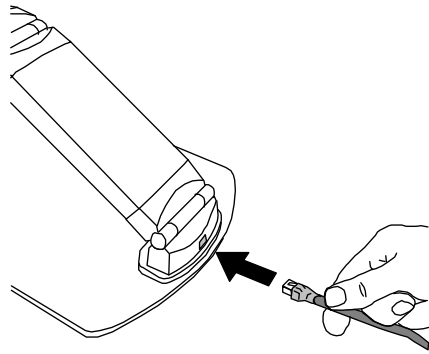

Insert the output cable into the rear of the camera.

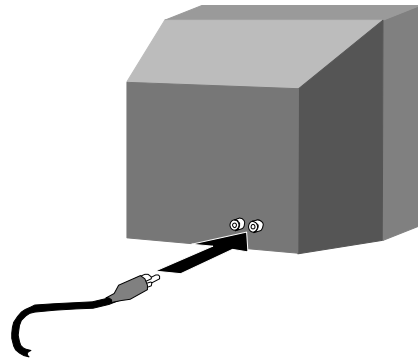

Plug the video connector into the **yellow** (video-in) jack either on the front or back of the television\*.

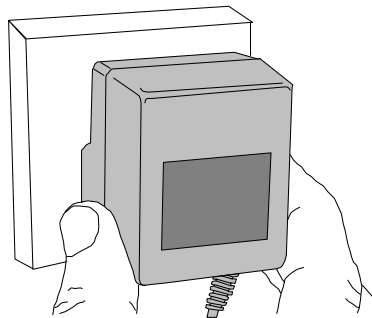

Plug the transformer into a wall socket and

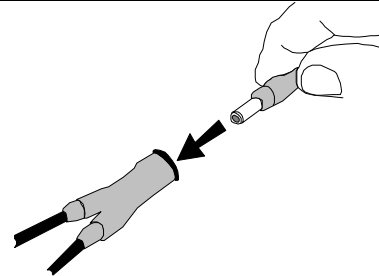

plug the power connector into the socket located mid-way along the output cable.

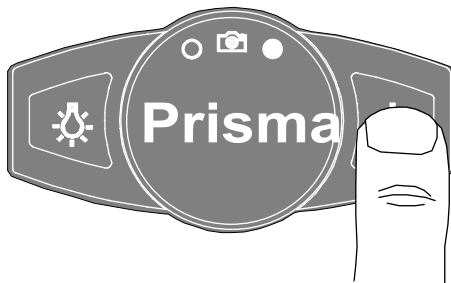

Power on the Prisma.

Power on the TV and use your remote control or control panel to switch to

**%Video+** or 

\*If you do not have a direct video input on your TV you will require an RF modulator . contact your Prisma distributor.

# Controls

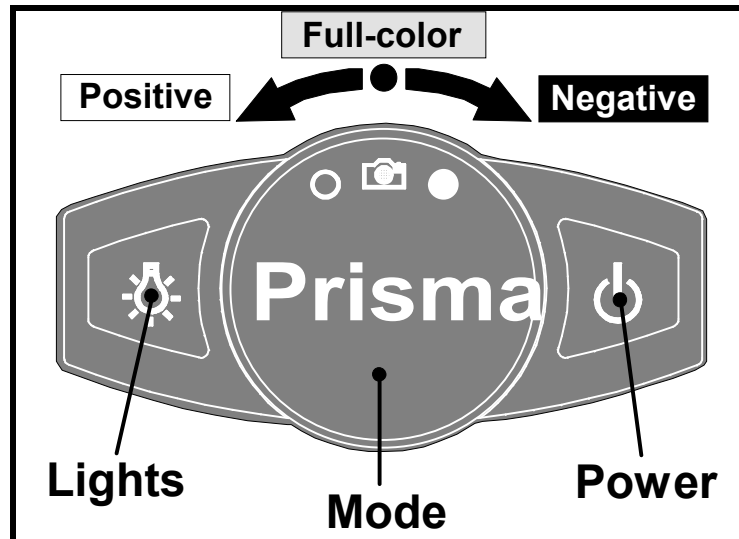



## Power

Push the button to turn the power on. The lights will flash briefly to indicate the power has been switched on. Push the button again to turn off the power.

## Lights

Push to turn on the internal supplemental lights. Push again to turn them off.

## Mode

-  Rotate clockwise for negative mode (white letters on a black background).
-  Rotate counter-clockwise for positive mode (high contrast black on white).
-  The center position produces full color for general viewing (Photo mode).

## Magnification

The magnification is determined by the height of the camera above the reading material. The best way to adjust this is to place one hand firmly on the tabletop,

and raise or lower the camera with your other hand as in the diagram below.

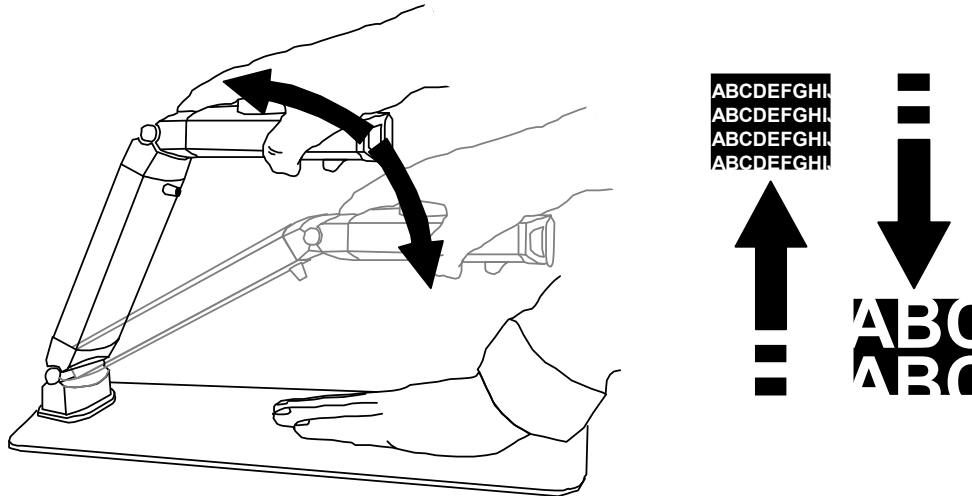

Lower the camera for higher magnification; raise it to reduce the magnification.

Use the lowest magnification you are comfortable with because:

- It is easier to locate your position on the page;
- There is less need to move a book on the table;
- The focus will work over a greater depth.

### **Focus**

If you change the height of the camera, or if the thickness of the material being read is changed, you will need to re-focus the camera. Rotate the focus control on the top of the Prisma until the image is at its sharpest. The direction of rotation is unimportant.

### **Brightness Control**

Located under the top hinge, this control adjusts the image to accommodate extreme lighting conditions so that the text does not fade into the background when moving.

# Using the Prisma

## Reading with the Prisma

Place the Prisma on a suitable table near the television and sit in front of it. Ideally the television should be at eye level or slightly below, and the Prisma reading table should be level with your elbows when seated. A good reading position prevents problems with your back, neck and arms.

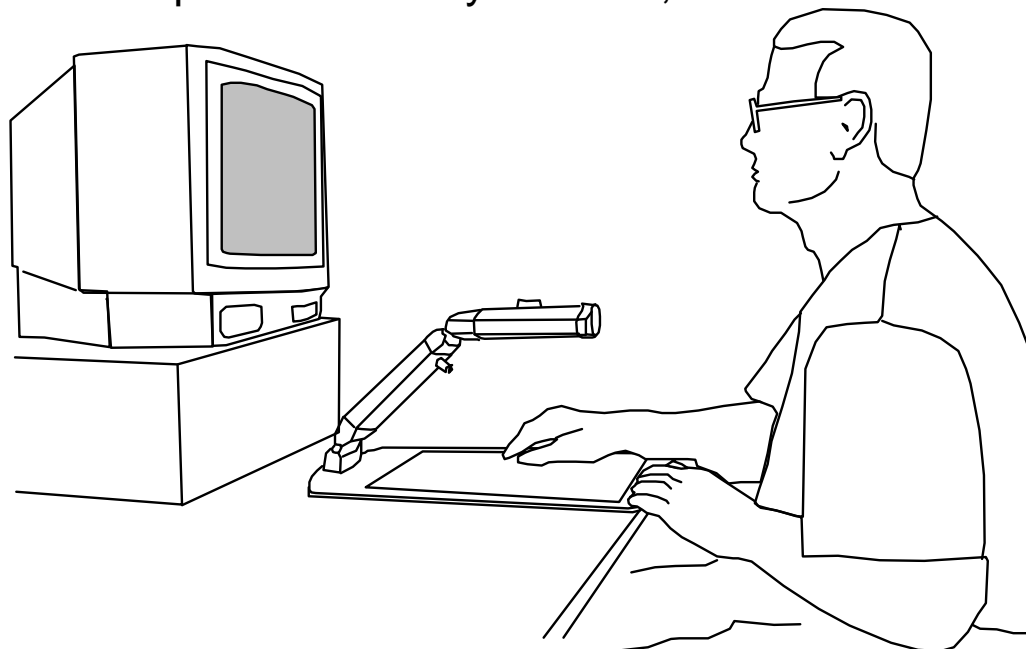

Place the material you wish to read on the reading table and adjust the focus knob until a sharp image is obtained. Adjust the magnification as described above to suit and re-focus if necessary. Ensure the camera head is horizontal for optimum image quality.

Move the book on the table until you locate the top of the page and then locate the start of the text. Simply slide the book side to side and watch the television screen while reading.

There is a mat provided with your Prisma to facilitate reading heavier materials. Place the mat across the reading table with the rubber side upwards. Place

the book on the mat and slide the mat from side to side.

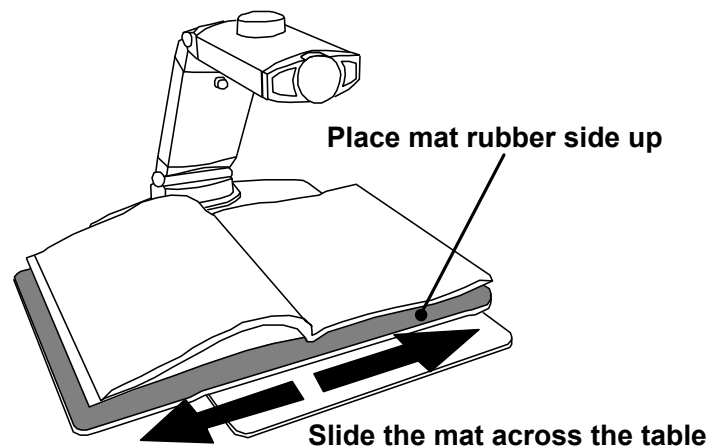

## Writing

Remove the mat from the table. Place the page under the camera and locate the area of the page where you wish to start writing. Holding the page firmly, bring your pen, raised well above the paper, until the nib is visible on the screen at the point you wish to write. Lower the pen to the paper carefully and write. You should watch the screen as you write.

## Hints and Tips

Locating the Prisma camera in a well-lit area will enhance the image available from the unit. If possible, avoid direct overhead lighting as this can cause shadows on the page leading to shading differences on the screen.

If you require subdued lighting, you should switch on the Prisma's lights, otherwise the picture will become noisy.

When using glossy paper, tilt the camera head upwards slowly until the reflections move off the screen.

# Taking Care of your Prisma

Do not touch the lens. Dirt on the lens will appear as a blurred or dim image or as fuzzy spots on the screen. If you believe the lens is dirty, it can be cleaned with a **soft**, dry cloth applying minimal pressure. As the lens is polished and coated, do **not** use a wet or coarse cloth, detergents, abrasive substances or solvents to clean it.

When transporting the Prisma we recommend that you use the carrying case provided. Do not allow the transformer or cables to move about within the case, as they may cause damage.

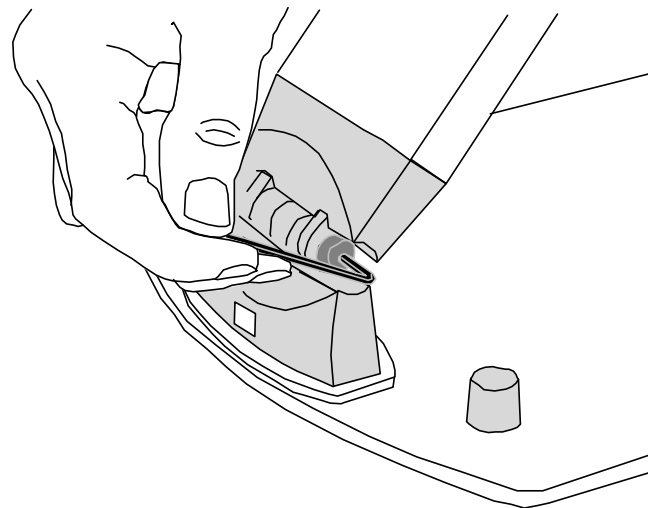

If the hinges loosen with use they can be tightened with the Allen key provided. To do this, pull off the caps covering the hinge screws and insert the Allen key into the screw head. Turn each screw clockwise about a quarter turn . do not over-tighten. Replace the caps. Loosening of the hinges is not covered under the terms of warranty; it is a user-maintenance issue.

Only use the transformer supplied with the unit and inspect the cabling regularly for damage. The



transformer is rated for use only within your home country . if you wish to use your Prisma abroad consult your distributor first, as both voltages and television standards vary throughout the world.

## Specifications

Dimensions:	Table area: 9½+x 16+ Folded height: 2½+ Max clearance under camera: 8½+ Weight (base unit): 2lb 6oz
Power:	12V 300mA from the transformer provided.
Modes of Operation:	High-contrast positive, high contrast negative and full color normal.
Magnification:	13+screen X3.5 to X35 20+screen X5 to X52
Temperature:	Storage: 15°F to 100°F. Operating: 40°F to 95°F
Output	1Vpp composite video NTSC 60Hz color

As we strive to constantly improve our products, this information is subject to change without notice.

Do not use this product in damp conditions (eg the bathroom)

**This device complies with Part 15 of the F.C.C. rules.**

**Operation is subject to the following conditions:**

- (1) This device may not cause harmful interference.**
- (2) This device must accept any interference received including interference which may cause undesirable operation.**

# Warranty

Ash Technologies warrants the equipment, when purchased new, to be free from defects in material and workmanship and will repair or replace at Ash Technologies' discretion, any equipment which exhibits such defects; provided that the equipment has been operated under the proper conditions of installation and has not been tampered with by any persons not authorized by Ash Technologies or its agents and that it is solely serviced by Ash Technologies or its agents.

In no event shall Ash Technologies or its agents be liable for special, indirect, incidental or consequential damages; the original user's remedies being limited to repair or replacement. This warranty is valid only when serviced in the country of original purchase.

**Ash Technologies makes no other or further warranty, express or implied, including and warranty of fitness for a specific purpose or warranty of merchantability.**

**This warranty is valid for a period of  
12 Months  
effective from the date of delivery.**

**For warranty claims or service during  
or after warranty period please  
contact your distributor.**



Ash Technologies Limited, B5, M7 Business Park, Naas, Ireland.  
info@ashtech.ie    www.ashtech.ie