

# **CLOVER 4**

## Handheld Video Magnifier

### **User Guide**

Rev E

---

# Contents

<b>Precaution</b>	<b>1</b>
<b>Quick Start</b>	<b>3</b>
<b>Overview</b> .....	<b>3</b>
<b>Compositions</b> .....	<b>5</b>
<b>Accessories</b> .....	<b>8</b>
<b>Battery and Charging</b> .....	<b>9</b>

---

---

<b>Writing Stand</b> .....	<b>14</b>
<b>Operation</b>	<b>15</b>
<b>Power Button</b> .....	<b>15</b>
<b>Beep Type</b> .....	<b>16</b>
<b>Magnification</b> .....	<b>18</b>
<b>Color Mode</b> .....	<b>19</b>
<b>Brightness</b> .....	<b>22</b>

---

---

<b>Two-Color Tuning</b> .....	<b>23</b>
<b>Lighting</b> .....	<b>25</b>
<b>Freeze</b> .....	<b>25</b>
<b>TV Connection</b> .....	<b>27</b>
<b>Memory</b> .....	<b>29</b>
<b>Auto power saving</b> .....	<b>29</b>
<b>Restore</b> .....	<b>30</b>

---

---

**Troubleshooting 31**

**The unit does not turn on ..... 31**

**Black screen or White screen ..... 31**

**The image does not change ..... 33**

**Smudges or blemishes on the screen ..... 33**

**Specifications 34**

---

## Precaution



Before using Clover 4 for the first time, you must charge its battery. Refer to **Battery and Charging** section for more details.



Always operate the unit in a place where the temperature is between 10°C and 35°C (50°F and 95°F).



Keep the unit away from wet areas, rain, and other sources of liquids. Do not submerge the unit.



Do not attempt to repair the unit. Any unauthorized attempt will void the product warranty. Contact your distributor to service.



Use the supplied power adapter and battery.

## Quick Start

### Overview

Thank you for purchasing CLOVER 4.

CLOVER 4 is a portable, handheld video magnifier with a 4.3 inch widescreen LCD display, providing sharp, clear images that are easily viewed in various magnification levels and color modes.

The unit allows you to put it on or close to the object. It supports continuous zoom, and the images can be



frozen for further viewing. It also has an integrated fold-away writing stand. This unit is ideal for viewing labels, books, newspapers and so on.

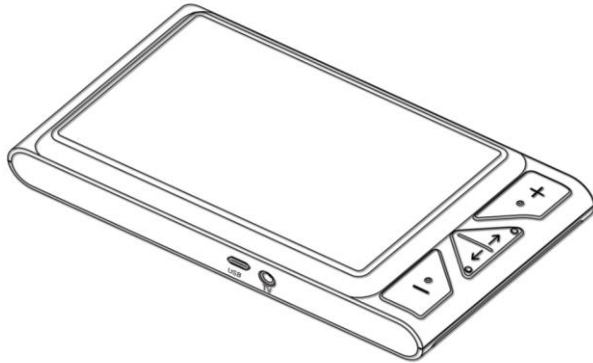

## Compositions

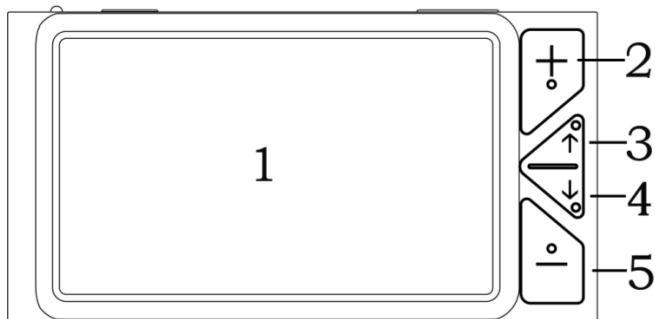

1. LCD Screen

3. Color Mode Up

5. Zoom Out

2. Zoom In

4. Color Mode Down

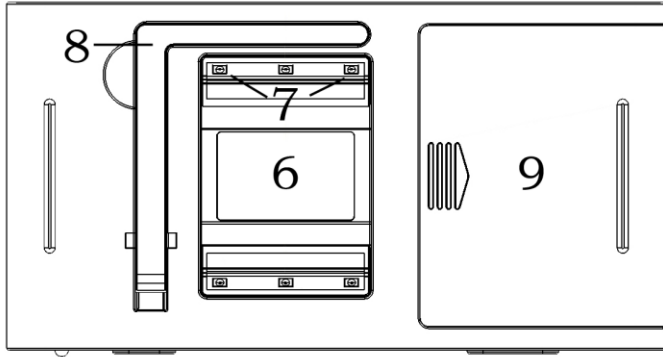

6. Camera

8. Writing Stand

7. LED Lights

9. Battery Slot

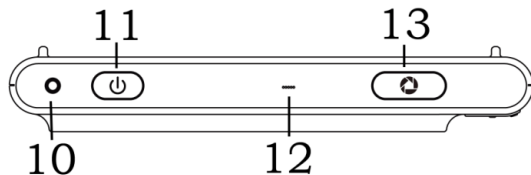

10. Power LED

11. Power

12. Beep

13. Freeze

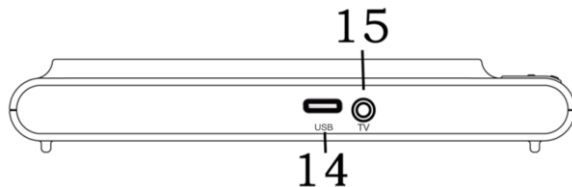

14. USB Type-C Port

15. TV Port

## Accessories



User Manual



Power  
Adapter



Cleaning Cloth



Carrying  
Case

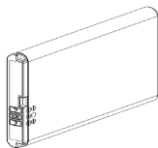

Battery

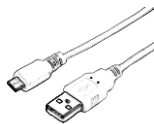

USB Cable



TV Cable

## Battery and Charging

### Battery installation

1. Turn the unit to make the back face up

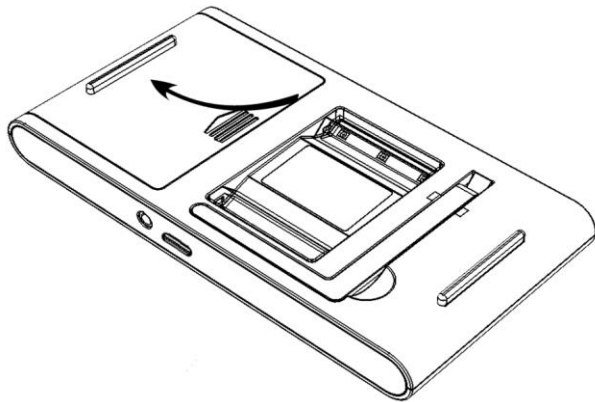

- 
2. Press the arrow icon on the battery cover and slide outward to open the battery cover
  3. Insert the battery to the right position in battery slot
  4. Place and slide back the battery cover

## **Charging the Battery**

1. Connect the supplied USB cable to the power adapter
2. Connect the supplied USB cable to the USB port on the unit

3. Plug the power adapter into an AC outlet and start charging

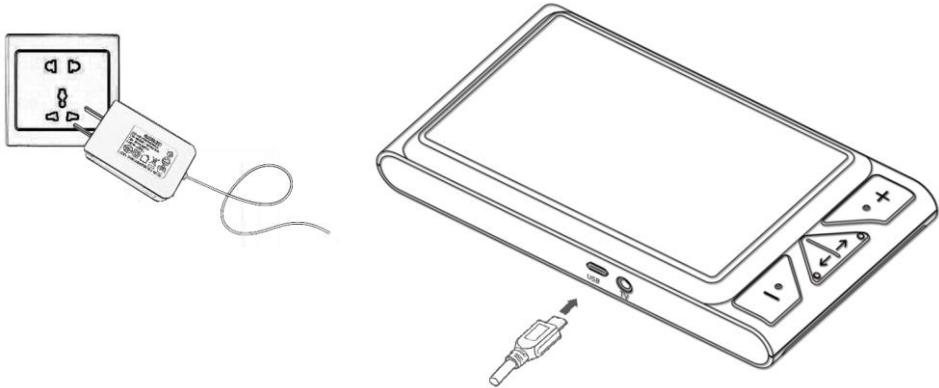



---

## **The Status of Power LED Indicator**

- Charging when the unit is off, the power LED will be green, and then auto turn off when fully charged. A full charge will take about 5 hours, and will support the unit working continuously for about 3 ~ 3.5 hours
- Charging when the unit is on, the power LED will be green

- 
- When the unit is on and the power adaptor is not connected, the power LED will be green when the battery level is high and will be red when the battery level is low. When the red light starts to flash, you will need to charge the battery
  - You can also check the battery status by pressing the power button. Please refer to the following instructions for more details

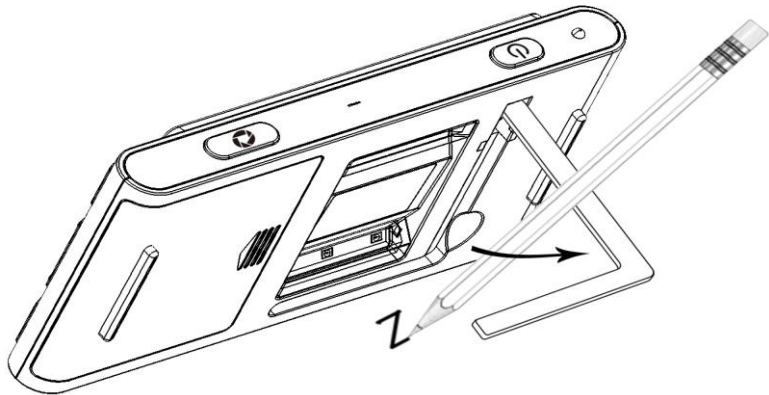

## Writing Stand

Open the writing stand as the following figure shows. And you can write under the camera.



## Operation

### Power Button

- Press and hold the power button  for 3 seconds to turn on the unit when it is off
- Press and hold the power button  for 3 seconds to turn off the unit when it is on

- 
- ❑ When the unit is on, press the power button  to check the current status of battery capacity, color mode, freeze mode and beep
  - ❑ Press other buttons when holding the power button will make combo functions. Refer to the following instructions for more details

## **Beep Type**

- Unit on/off beep

- Button beep
- Threshold beep
- Low battery beep

### **Beep Control:**

- Press and hold the freeze button  for 3 seconds to turn on/off the beep

## Magnification

- ❑ Press the Zoom In button  $+$  to increase magnification, and hold the Zoom In button  $+$  for continuous increase
- ❑ Press the Zoom Out button  $-$  to decrease magnification, and hold the Zoom Out button  $-$  for continuous decrease
  
- Normal magnification mode: 3.5x ~ 16x

## Color Mode

A color mode is a pre-defined color combination. Full color mode is suitable for pictures and maps. Enhanced Contrast mode is combined with different foreground and background colors and can help users to read more clearly.

- Press the Color Mode Down button ↓ to cycle in one direction through the color combination list
- Press the Color Mode Up button ↑ to cycle in the other direction through the color combination list



- ❑ Press the Color Mode Up button ↑ and the Color Mode Down button ↓ at the same time to quickly switch between Full color mode and current Enhanced Contrast mode
- ❑ Holding the Color Mode Up button ↑ and the Color Mode Down button ↓ at the same time for 5 seconds to switch between the Simplified Color Combination List and the Integrated Color Combination List (factory default)

---

The Simplified Color Combination List (6 modes):

- |  |   |
|--|---|
| <input checked="" type="checkbox"/> Full Color     | <input checked="" type="checkbox"/> White on Black  |
| <input checked="" type="checkbox"/> Black on White | <input checked="" type="checkbox"/> Yellow on Black |
| <input checked="" type="checkbox"/> White on Blue  | <input checked="" type="checkbox"/> Yellow on Blue  |





The Integrated Color Combination List (20 modes)

- |   |   |
|---|---|
| <input checked="" type="checkbox"/> Full Color      | <input checked="" type="checkbox"/> White on Black  |
| <input checked="" type="checkbox"/> Black on White  | <input checked="" type="checkbox"/> Yellow on Black |
| <input checked="" type="checkbox"/> Black on Yellow | <input checked="" type="checkbox"/> White on Blue   |
| <input checked="" type="checkbox"/> Blue on White   | <input checked="" type="checkbox"/> Yellow on Blue  |
| <input checked="" type="checkbox"/> Blue on Yellow  | <input checked="" type="checkbox"/> Green on Black  |

- |   |   |
|---|---|
| <input checked="" type="checkbox"/> Black on Green  | <input checked="" type="checkbox"/> Violet on Black |
| <input checked="" type="checkbox"/> Black on Violet | <input checked="" type="checkbox"/> Blue on Black   |
| <input checked="" type="checkbox"/> Black on Blue   | <input checked="" type="checkbox"/> White on Green  |
| <input checked="" type="checkbox"/> Green on White  | <input checked="" type="checkbox"/> White on Red    |
| <input checked="" type="checkbox"/> Red on White    | <input checked="" type="checkbox"/> Red on Black    |

## Brightness





Brightness is adjustable both in Full color mode and Enhanced Contrast mode. Factory default value will be highlighted green.

- ❑ Combo: Power button  and Zoom In button , increase the brightness
- ❑ Combo: Power button  and Zoom Out button , decrease the brightness

## Two-Color Tuning

By fine adjusting the combination of foreground and background color in Enhanced Contrast mode, the tuning will improve the adaptability for viewing

different materials. Factory default value will be highlighted green.

- ❑ Combo: Power button  and Color Mode Up button  , more background color
- ❑ Combo: Power button  and Color Mode Down button  , more foreground color









## Lighting

- Combo: Power button  and Freeze button , turn on/off the LED Lighting

## Freeze

Freezing an image on the LCD screen can be useful for further viewing. Magnification and color changing are also allowed for a better view. However, the brightness adjusting is not allowed when the image is frozen.

- Press Freeze button  to lock the active image



- ❑ Press again Freeze button  to unlock
  
- ❑ When increase the magnification of the locked image, you can use the following combo button to navigate
  - Power  & Color Mode Up  , navigate upward
  - Power  & Color Mode Down  , navigate downward
  - Power  & Zoom In  , navigate leftward
  - Power  & Zoom Out  , navigate rightward

## TV Connection

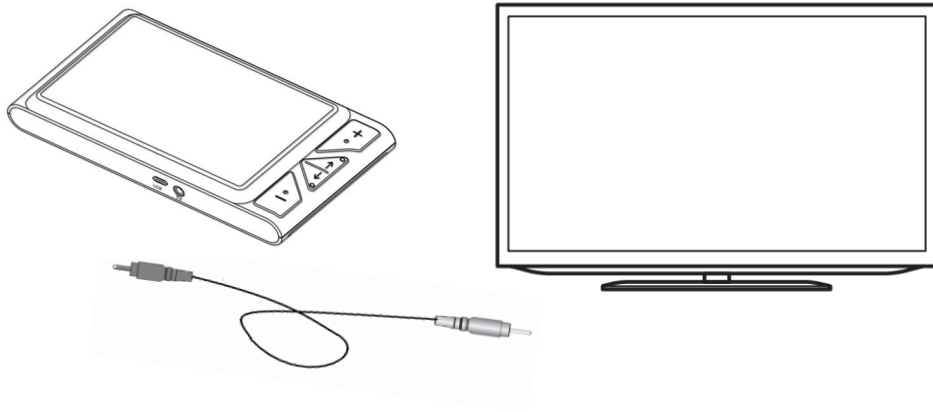
Connect to your TV for better and larger viewing.





- ❑ When plugging the TV Cable in the TV port on the unit, you need to select the appropriate TV output mode (PAL or NTSC mode).
- ❑ Press Zoom In button  or Zoom Out button  to choose PAL or NTSC modes, then press Freeze button  to confirm your selection and then the image shall be shown on TV
- ❑ After unplugging the TV cable, the image will automatically return to the LCD screen of the unit



## **Memory**

The unit will memorize automatically the most recent settings such as color mode, magnification and beep when power is off normally. And the unit will apply these settings when power is on next time.

## **Auto power saving**

If no operation and no moving for over 3 minutes, the unit will turn off automatically.

## Restore

- ❑ Holding the Freeze button  and the Zoom Out button  at the same time for 3 seconds to reset to the default factory settings. Auto power off when resetting is done.

## Troubleshooting

### **The unit does not turn on**

- Connect to the power adapter
- Charge the battery
- Reinstall the battery

### **Black screen or White screen**

- If the unit is sitting on a flat pure surface, the screen may be black or white. Lift the unit to ensure the change happens

- Adjust the magnification
- Adjust the color mode
- When the unit is connected to TV, the screen is black
- Restart the unit
- Reinstall the battery

---

## **The image does not change**

- If the unit enter into the freeze mode, the image will not change
- Press power button to check the current status
- Restart the unit
- Reinstall the battery

## **Smudges or blemishes on the screen**

- Adjust brightness
- Clean the LCD screen and camera

Please contact your local distributor if the problem is not solved.

## Specifications

- **Display:** 4.3 inch widescreen LCD
- **Size:**  $\leq 152 \times 80 \times 22$ mm
- **Weight:** <180 grams (Battery included)
- **Color Mode:** Simplified 6 modes; Integrated 20 modes
- **Magnification:** Approximately 3.5x ~ 16x
- **Battery:** Rechargeable & detachable Li battery  
Nearly 3~3.5 hours continuous use

---

Charges in approximately 5 hours

- **Power Adapter:** USB port; input 110-240V; output 5V/1A