



Owner's Manual

WATER-PRO SERIES

MODULAR S-90 12/24V DC

Version: 161026

Reference: 45109013

Eco-Sistems Watermakers, S.L.

Oficina: C/ Horta nº 22 – Almacén: C/ Gran Vía Puig i Cadafalch nº 233
(08203)- Sabadell – Barcelona (Spain)

Tel: 34.93.710.89.50 – Fax: 34.93.712.23.55

E-mail: info@eco-sistems.com

Web: www.eco-sistems.com

WATER-PRO MODULAR S-90 12/24V DC

MEMBRANE VESSEL
90 LITRES

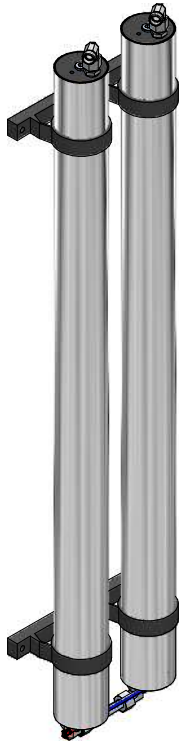

2-HC

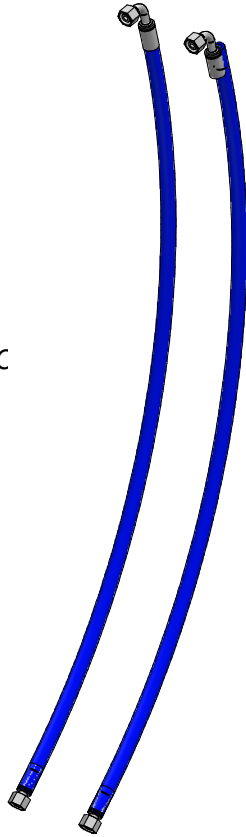

TUBE Ø4X2



TUBE Ø8x6 BLUE



HOSE 1/2 BLUE

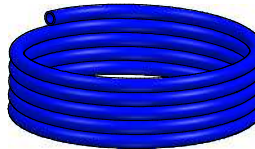

HOSE CLEAR BRAID Ø20



CONNECTOR Ø8 TUBE X
1/4 BSP PLASTIC

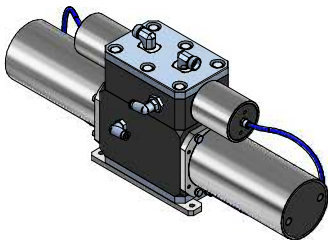

ST-15/CERAMIC
ECO-SYSTEMS PUMP

2-ADAPTER 1/2 BSP X
1/2 BARB PVC



ADAPTER 1/2 BSP X
3/4 BARB PVC



SEA STRAINER SET

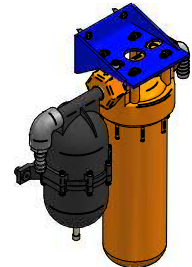

4 - HOSE CLAMP Ø16/27



10 -HOSE CLAMP Ø12/22

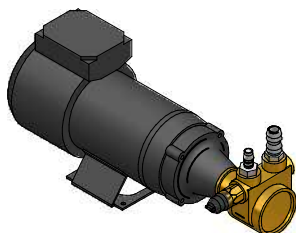

MOTOR PUMP
12/24 V DC SET



ELECTRONIC
CONTROL PANEL



INVERTER BOX

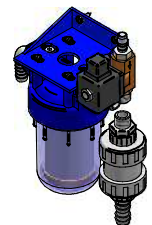

FILTER WRENCH

PANEL CONTROL SET



FWF FILTER SET

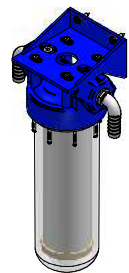

LOW PRESSURE FILTER SET

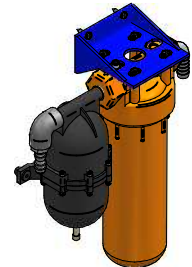

TABLE OF CONTENTS

CHAPTER I:

- **Installation, operation and maintenance.**

CHAPTER II:

- **Storage and Cleaning.**

CHAPTER III:

- **Parts listing and exploded view of
ST-15/CERAMIC Eco-sistems Pump**

CHAPTER IV:

- **Filter and Membrane Replacement.**

CHAPTER V:

- **Warranty and identification sheet.**
- **Dealers and After-Sale Service List.**

CHAPTER I

**INSTALLATION, OPERATION
AND MAINTENANCE OF THE
EQUIPMENT.**

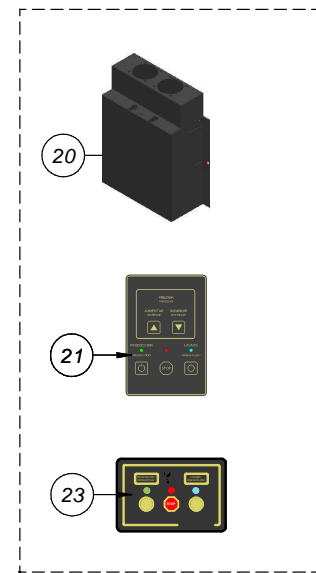
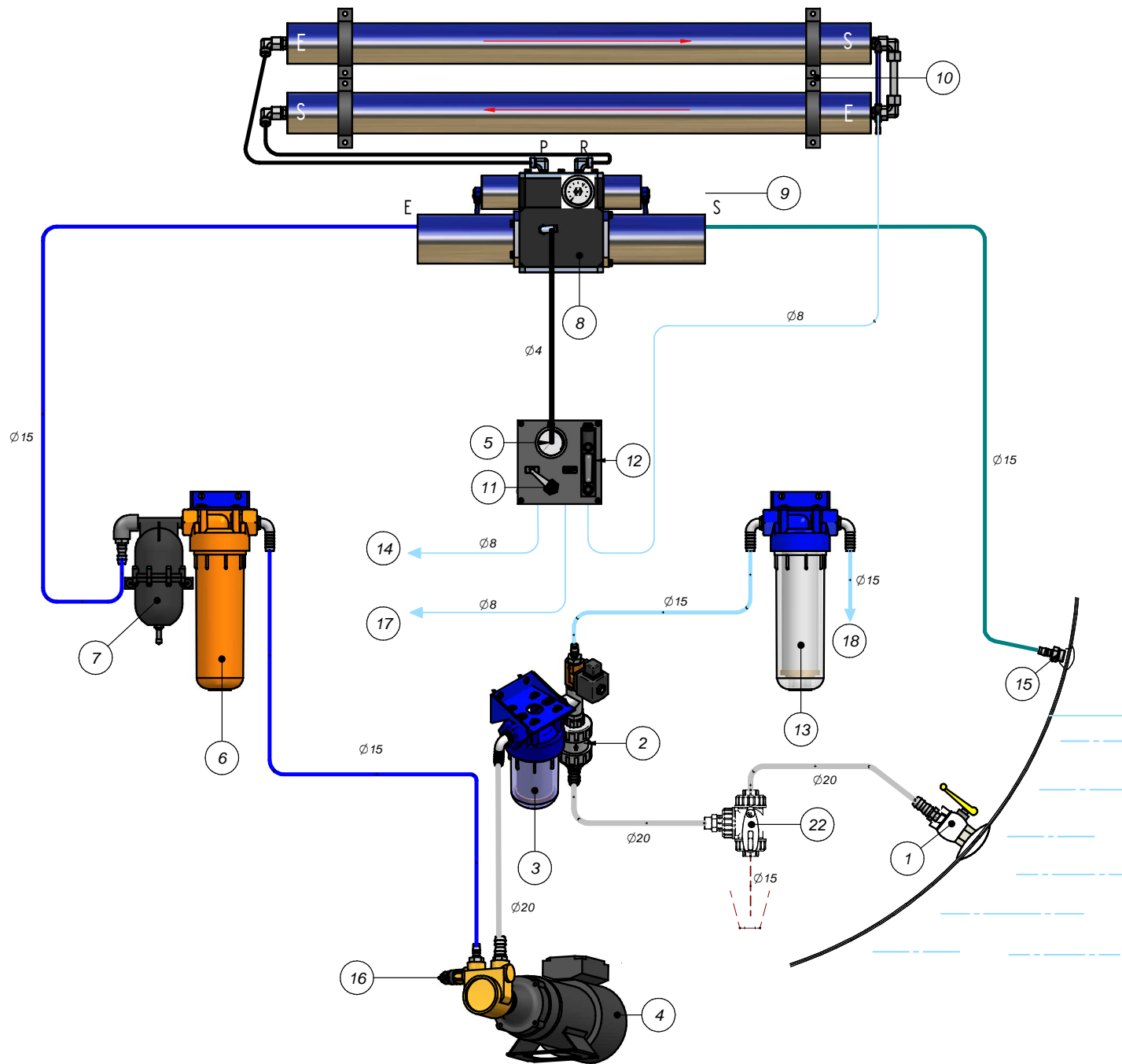

CONEXIONADO VER PAG.6

WATER-PRO MODULAR S-90 12/24V DC

SYSTEM COMPONENTS

1. - Seacock valve to uptake the seawater.
2. - Check Valve.
3. - Protection pre-filter. (Washable mesh filter).
4. - Low-pressure booster pump. 12/24V DC motor.
5. - Low Pressure Gauge.
6. - 5 microns filter container.
7. - Expansion Vessel.
8. – ST-15/CERAMIC High pressure pump with energy saving system. Energy recovering.
9. - High Pressure Gauge.
10. - R.O. Membrane and Vessel.
11. -Three ways valve for the produced water.
12. - Produced Water Flow meter.
13. - Anti Cl carbon filter.
14. - Produced water output to the tank.
15. - Brine discharge thru-hull.
16. - Switch.
17. - Direct produced water output. (CONTROL)
18. – Boat fresh water input
19. - FLUSHING Solenoid Valve.
20. - Power Box.
21. - DIGITAL Control Panel.
22. – (OPTIONAL) Three way valve for wintering.
23. - (OPTIONAL) Remote Control Panel.

I I.1. Installation. (See diagram Chapter I Pages 1 and 2)

To assemble the unit you will need to have the following inlet and outlet connections ready:

- Seacock (1) with a minimum nominal pitch of 3/4" Gas responsible for water intake, which should be located as low as possible on the bottom of the hull in order to prevent possible cavitation problems due to air aspiration.
- 1/2" Gas female thread through-hull (15) fitting for connecting the internal blue tube Ø12 that drains the rejected water into the sea.
- 1/4" Gas female thread inlet in the main tank for the intake of fresh water produced.
- 1/2" Gas female inlet for pressurised intake of water used on the watermaker's cleaning process.

WARNING

It is very important to place the sea strainer (3) as close as possible to the motor pump (4), making shure both of them are located below the waterline, lastly, check that at least a minimum flow of 5liters/minute is supplied to the motor pump (4), to prevent it from cavitations due to a pressure fall.

The other components belonging to the unit can be located at a higher level, provided that they do not exceed a distance of 4 or 5 metres and taking into account that the membrane (10) and the high pressure pump (8) must be connected by the 1 meter long high pressure tubes. In longer distances, pressure drop increases significantly, increasing the power consumption.

The membrane's building position is irrelevant (vertical/horizontal), but in case of placing it in a vertical position, the outlet fresh water tube has to be on the upper part.

The membrane is normally delivered assembled inside the high-pressure container. If it has not been factory-installed look in Chapter IV for installing information.

After all components have been put in place and fixed, the unit will be ready for hydraulic and electrical connection, which will be covered in the following sections.

I.2. Hydraulic connections.

The connection between the various components is made with the tubes included within unit, as shown in the diagram in Chapter I Pages 1 and 2.

The two suction connections between the points described below are made using the transparent tube Ø20

- Lower check valve inlet (2) and sea cock valve (1).
- Sea strainer outlet (3) and pump inlet (4).

The connection between the boat pressurized water intake to the carbon filter inlet (13) and, the carbon filter outlet and the electrovalve inlet (19), are to be made with the Ø12 blue tube.

As a general rule, the tube sections should be as short and as straight as possible to avoid unnecessary pressure drop, and the connections should be completely airtight so that air does not enter the circuit during the water suction process.

The remaining seawater circuit sections are made with the blue tube Ø12 (maximum pressure 20 bar) **It is a special tube developed to work with up to 20 bar pressures, and it's not recommended replacing it with a different one (even of similar characteristics)**

To make the connections proceed as indicated below:

- Pump outlet (4) and 5-micron pre-filter inlet (6).
- Pre-filter outlet (6) and the high-pressure pump (8) inlet elbow (E).
- Outlet elbow (S) of the pressure amplifier pump (8) and the brine outlet (15).

The referred elbows marked as E and S are located in the back / lower part of the high pressure pump (8)

To connect the high pressure pump (ETD) with the R.O. membrane vessel proceed to use a high pressure hose (blue with stainless steel terminals) from the stainless steel connection located in the brine outlet, marked with the letter (P) in the back side of the high pressure pump (8), with the stainless steel elbow located in the R.O. membrane vessel , marked as ENTRADA (E) Then proceed to connect link the R.O. membrane vessel elbow marked as SALIDA (S) to the stainless steel adaptor marked as (R) located at the high pressure pump(8).by using the other high pressure hose(blue with stainless steel connections).

By using the Ø4 polyamide tube, connect the end cap plastic adaptor (10), located in the membrane vessel inlet with the lower flow meter connector (12) as well as with the three way valve outlets (11), connect the left adaptor to the main tank adaptor (14), and the right adaptor to the produced fresh water outlet (17).

The feed Pump (4) is equipped with a pressure switch (16), calibrated to 18 bar that in case of over pressure would stop the system.

I.3. Hidraulic Control Panel.

The control panel shown in the diagram in Chapter I on Page 1 is made up of a flow meter (12) indicating the production of freshwater, a low-pressure gauge (5) and a three-way valve (11), which should be connected as follows:



- Blue Ø 8 polyamide tube to connect the end cap plastic adaptor (10), located in the membrane vessel inlet, to the elbow located in the lower part of the flow meter (12).
- Blue Ø 8 polyamide tube connecting the three way valve “MAIN TANK” outlet (11) to the boat’s main tank.
- Blue Ø 8 polyamide tube from the three way valve “PRUEBA/TEST” outlet (11) to an accessible fresh water point, such as a tap installed in the kitchen.
- White Ø 4 polyamide tube between the gauge (5) and the fast connector on the intermediate plate of the pump (6). There can’t be any constrictions in this tube.

I.4. Electronic Control Panel

The electronic Control Panel (20), shown in the diagram Page 1 Chapter I consists of a potentiometer which controls the speed/power in the feed pump motor (4) and three buttons equipped with indicator lights that allow the complete control of the system.



- The first button, from left to right, is marked with the word PRODUCCION and is equipped with a green LED light. It starts the system.
- The central button, is marked with the word STOP and is equipped with a red LED light. It stops the system.
- The third button, from left to right, is marked with the word FLUSH and is equipped with a blue LED light. It starts the timed Fresh Water Flush System.

For a proper operation, the system doesn’t allow the change from the Production function to the Flush function without pressing the STOP button. The flushing time is programmed to last 120 seconds, working the system at 60% speed of the feed pump.

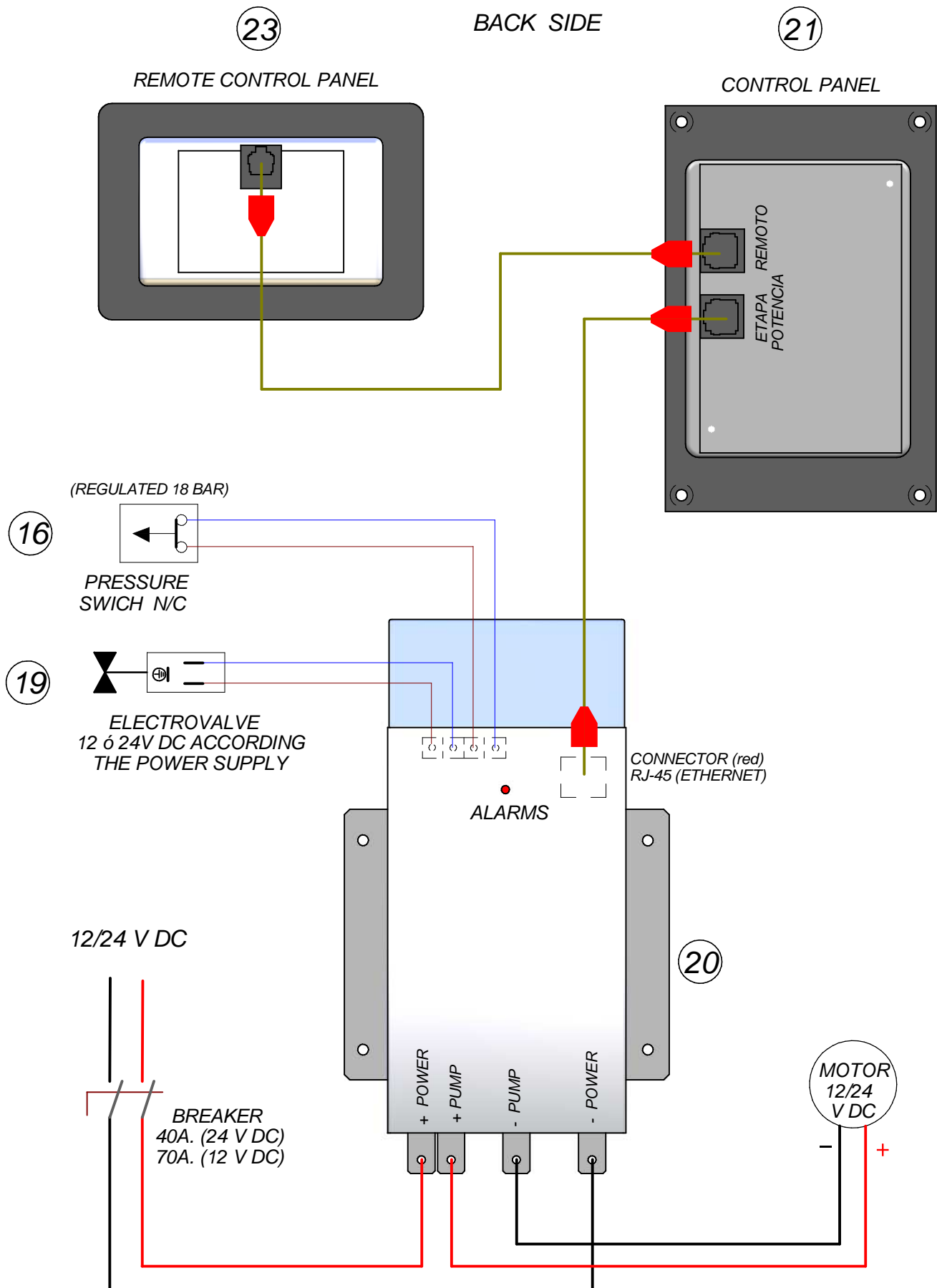

WATER-PRO MODULAR S-90 12/24V DC

I.5. Electrical Connection.

The system is equipped with a motor for the low-pressure pump of 12/24V DC 750 rated watts at 2000 rpm. It must be connected using the moisture shielded cable with a cross-section which has the appropriate section for the distance between the batteries and the motor. The recommended cables are the following ones:

Batteries / Power Box	Dist.	12 v DC Wire square	24 v DC
From 0 to 5 meters		35 mm ²	16 mm ²
From 6 to 12 meters		70 mm ²	25 mm ²
Circuit Breaker		70 Amp	40Amp

These sections are appropriate to prevent voltage losses greater than 1.6% of the rated voltage (0.2 V in 12 V DC).

In no case should a distance of more than 3 meters between the power box and the electric motor in the low pressure pump be exceeded. For longer distances than the ones provided in this table, please contact the manufacturer.

- Connect the two wires from the breaker with the corresponding power box terminals marked as power suppliers (21) as indicated in scheme (Chapter I Page 6). Connect the solenoid valve coil (19) and the switch (16), with the corresponding power box terminals (21), and connect motor-pump terminals (4) with the ones marked as “Pump” in the power box.
- Connect the control panel (21) and the head (20), using the supplied 6 meter cable with red connectors RJ-45 (Ethernet) at both ends, bareing in mind to connect it at the base marked as POWER STAGE. The remote control equipment (23) OPTIONAL must connect with the 10m cable on the base marked as REMOTE.
- Make sure the rotation direction in the pump is correct, which is marked by the water inlet and the outlet, if it doesn't, reverse the polarity on the motor connection. (Chapter I Page 6)

As a general rule, the electricity grid circuit should be suitably protected, taking care to oversize the connection cables to avoid voltage drops, besides an unnecessary power consumption.

ELECTRONIC 12/24 V DC CONTROL PANEL ADJUSTS

(Recommended for experts only)

FLUSH WATER FLOW ADJUST

- Switch on the system while pressing the flush button on the control panel until the blue led gets on.
- From that moment on every tap on the ▲ button will increase the pump speed in one unit, the same way every tap on the ▼ button will decrease the pump speed in one unit.
- Once reached the wanted flush water flow press the Stop button, the red led will get on, after releasing it the led will flash, this means the water flows has been adjusted.
- Disconnect the system and turn it on again to return it to it's the normal functioning.

POTENTIOMETER RANGE ADJUST

- Turn the speed adjust button to the maximum level and adjust the production trimmer (back side of the panel) until reaching the maximum speed wanted.
- Turn the speed adjust button to the minimum level and adjust the production trimmer (back side of the panel) until reaching the minimum speed wanted.
- Repeat both steps until reaching the wanted adjust.

HOUR METER READING

- Switch the system on while pressing the Stop button in the control panel.
- Both green and red leds will flash a few times.
- Each green flash is equivalent to 400 working hours and each red flash is equivalent to 25 working hours. The total reading of working hours of the system is given by the sum of all green and red flashes.
- The maximum count will be 8 green flashes and 3 red flashes, which makes a total of 3275 hour's reading, from that moment on, the hour meter gets self-restarted, starting a new reading cycle.
- The green led will flash 5 times when the system reaches 2.000 hours of working, which means the pump maintenance must be performed.

Switch off the system and switch it on again to return it to it's normal functioning.

ALARMS AND PROTECTION OF THE 12/24 V DC POWER BOX

- There is a 3 Amp fuse under the aluminum cover.
- If the aluminum radiator exceeds the 65 temperature degrees the red led located in the control panel will flash, then the power box will cut the power supplied to the motor pump and the power box, the fan will still working. To restore the original system conditions proceed to switch off and on the unit.
- If the maximum pressure is exceeded the red led will remain on. To restore the original system conditions proceed to switch off and on the unit.
- Both excessive temperature and pressure failure are caused by a failure in the system, so, the first thing to do is to find out the cause of the problem.

Remote Control Panel. (Optional)

The remote control panel (23) shown on the diagram of Page1 Chapter I consists of three buttons, each one with it's corresponding light indicator which allow a complete operation of the system from another point on the boat within a 10m radius.

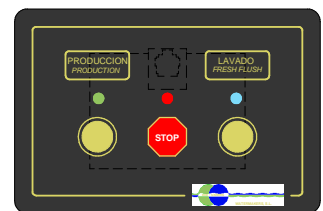

- The button marked with the word “PRODUCTION” and green LED on top . Start’s the system.
- The button with the word STOP and a red LED indicator on top. Stop’s the system.
- The button marked with the word’s “FRESH FLUSH” and a blue LED, is used to start the automatic washing process.

I.6. First Start Up.

- Check all connections have been properly made and the voltage at the terminals is the right one.
- Check if the Sea Cock Valve (1) is opened and the three way valve (11) is in the “*PRUEBA/TEST*” position, as shown on the diagram, so that the first fresh water produced can be rejected (17).
- Make shure we have pressure on the boat’s fresh water circuit.
- Turn on the system by pressing the “**PRODUCTION**” button and check that the direction of the pump’s rotation is the right one, gradually increase the pump motor speed with the potentiometer “**PRESSURE**” making sure not to exceed the 60Kg/cm² high pressure (green zone) indicated on the high pressure pump gauge (9).
- Check on the pressure gauge (5) that the powering pressure lies between a 9 and 11 kg/cm², and does not exceed 14 kg/cm² under any circumstances (red zone).The high pressure, indicated on the high pressure pump gauge (9), will gradually rise before stabilizing at approximately 50-55 kg/cm².
- In the first few minutes, some air bubbles will be observed in the panel control flow meter (12). Those bubbles come from the interior of the membrane and other system elements, causing some irregularities in the first high pressure work cycles. They usually go away without purging the circuit.
- Approximately 10 minutes after the start-up, the “control tank” should contain about 5 liter water produced (0.5 liter/minute), which determines that the production rate is correct. Press “**STOP**” to stop the feeding pump, and after that, by pressing the “**FLUSH**” button the system will activate the electro-valve (19) as well as the pump, which will work at a slower speed for about 120 seconds, stopping automatically once finished the flushing. By that time, a significant reduction in both high and low pressure will be noticed, due to the fact that the fresh water will have reached the membranes. This operation should be repeated at least twice to clean the new membranes and eliminate the membrane preservative that may have accumulated inside. During the flushing, the pressurized fresh water system in the boat must be “ON”, providing approximately a 5l per minute flow, at 2 Pressure Bars.

During this period of time, a significant reduction in both high and low pressures will be noticed, due to the fact that the fresh water will have reached the membranes. This operation should be repeated twice at least, to clean the new membranes and eliminate the membrane preservative that may have accumulated inside. During the flushing, the pressurized fresh water system in the boat must be “ON”, providing approximately 5 liters per minute flow, at a pressure of 2 bar.

I.7. Start-up

- Before starting the system, make sure the sea cock valve (1) is completely opened, the 3 way valve (11) is set to “*MAIN TANK*”, as indicated in the diagram, and the valve (2) is set in “*PRODUCTION*” so that the first produced water can be checked in a test tank (17).
- Make shure we have pressure on the boat’s fresh water circuit.
- Start the motor and check that the pressure in the control panel of the gauge (5) lies between approximately 10-12 kg/cm², and does not exceed 15 kg/cm² under any circumstances (red zone).
- High pressure will gradually rise until stabilising at approximately 45-60 kg/cm². There may be some differences depending on the water’s temperature.
- Two minutes later place the valve on the “*MAIN TANK*” position again.

I.8. Turning the unit off.

Before switching off the unit, the system must be cleaned to prevent compaction of the membrane due to the biological fouling in it. To do this make sure you have water from the boat’s system and proceed as follows:

- Press “*STOP*” to stop the low pressure motor pump.
- Press “*LAVADO/ FLUSH*” to start the flushing system.
- At this point the system will take fresh water from the pressurized fresh water system in the boat. The low pressure pump must be “*ON*”, providing approximately a 5l per minute flow, at a pressure of two Bars.

- The high pressure will fall to around 20-30 kg/cm². This significant decrease in high pressure means that the seawater contained in the membranes has been cleaned out and replaced by fresh water. Changing the salinity and pH of the water in the membrane prevents the biological fouling from latching on to it for a maximum period of 90 days. For longer periods see **Chapter II Storage and Cleaning**.
- **As a safety measure, always close the seacock valve (1) when the system is turned off.**

I.9. Maintenance of the unit.

- Regularly check the status of the Sea Strainer for the admission of seawater (3) and clean the mesh of impurities when needed.
- Change the 5 micron filter for a new cartridge when you see that pressure has risen from 1.5 kg/cm² to 2 kg/cm² more than the figure indicated by the control panel low-pressure pressure gauge (5) at the start of operation with a new filter. This cartridge must always be replaced at the beginning of each season or at least once every three months in the event of continuous service.
- Change the active carbon cartridge at least once a year.
- When the high-pressure pressure gauge (9) exceeds 65 kg/cm² (with a water temperature between 18°C and 25°C), the used membrane should be replaced by a new one.
- Periodically check the pressure of the accumulator (7), it may be 7 Kg/cm² pressure, not to produce low pressure oscillations

(An annual inspection by the Technical Support Service is recommended).

CHAPTER II

STORAGE AND CLEANING.

VERY IMPORTANT

REMEMBER THAT FOR A LONGER LIFE OF YOUR MEMBRANE, YOU MUST CLEAN THE SYSTEM WITH FRESH WATER AFTER EVERY USE .

II.1. Storage Precautions.

PREVENTION AGAINST CHEMICAL ATTACKS ON THE SYSTEM:

Do not use for storage purposes, or expose the unit to, hydrogen peroxide, chloramine, chloramine-T, N-chloroisocyanide, chlorine dioxide, hypochlorite, chlorine, iodine, bromine, bromide, phenolic disinfectants or any other chemical element. The use of unauthorised chemical elements or the abuse of authorised ones will invalidate any warranty.

TEMPERATURE:

Never expose the membrane to storage temperatures higher than 50°C or lower than 0°C. Never store the membrane vessel under direct sunlight. Freezing temperatures will result in mechanical damage to the system due to the water expansion during the freezing process. This will cause irreversible damage to the membrane.

DRYING OUT:

Never allow the membrane to dry out. If the membrane is allowed to dry out, up to 30% of production flow will be lost. This will cause irreversible damage to the membrane. The membrane must always be kept damp.

BIOLOGICAL DIRT:

Protect the membrane from biological dirt. Up to 40% of production flow will be lost if the membrane is allowed to become dirty with biological slime. Some production, but not all, can be recovered by following a thorough cleaning.

CHEMICAL DIRT:

Protect the membrane from chemical attacks or dirt. Be careful when using the system in ports that may be polluted with chemical products, oil or fuel. Chemical attacks are not covered by the warranty.

STORAGE:

The inside of the membrane, which is dark and damp, is an excellent place for microorganisms to reproduce. When the membrane is used, tested or operated intermittently, it is exposed to microorganisms. Up to 50% of production flow can be lost if the membrane is not stored correctly.

II.2. Shutting down for short periods of time.

Shutting down for a short period of time means when the unit will not be used for between one day and three months. An excellent and inexpensive way to protect the system and the membrane is set out in the **Switching off the unit** section which guarantees protection against the biological fouling in the membranes. As manufacturers we recommend that **immediately after** using the system you always wash it with freshwater from the “Main Boat Tank” sent through the carbon filter (13) in order to get rid of all traces of chlorine that may be in the water in the tank.

II.3. Shutting down for long periods of time.

(Recommended for experts only)

A long period of time or prolonged shutdown means when the unit will not be used for four months or more. In this case the unit must first be rinsed with chlorine-free drinking water, and then stored with a chemical protector. This product inhibits bacteria growth while maintaining a high circulation flow and salt rejection in the membrane.

Follow these instructions carefully:

1. Before switching off the unit: make sure you have enough water in the boat’s main tank and also fill up another container with 5 liters of additional water that will be used to dissolve the preservative.
2. Press the “**FLUSH**” button and let the system be washed with fresh water from the boat tank. Remember that whenever the system is flushed, **the pressurized fresh water system must be “on” and that there has to be enough water in the main tank.** (14). Within 1 to 2 minutes period a huge decrease of the high pressure will be produced and finally it will stabilize at 20-30 Kg/cm², that fall will indicate the system has been washed with fresh water. It will then automatically stop.

3. Dissolve 30 to 40 grams of chemical protector (sodium metabisulfite) with the 5 liters of water you set aside in a different container and suction this solution using the auxiliary valve (22).
4. Close the Sea Cock Valve (1), Start up the system by pressing **LAVADO**, and press **STOP** just before the chemical protector and water solution from the tank runs out. This means the entire circuit will contain this protecting solution.

Do not forget to shut off the sea cock valve (1) as a security measure.

5. When the unit is ready to be turned on once again, the valve (1) must set to the open position and the valve (11) to the “*PRUEBA/TEST*” position so that the water produced initially is rejected. Proceed as described in **I.6 FIRST START-UP (Chapter I Page 10)**.

Warning

Sodium metabisulfite is a caustic product that may cause serious irritation to the skin and mucus membranes. Take due precautions before handling, do not touch it directly and always work in well-ventilated spaces.

CHAPTER III

PARTS LISTING EXPLODED VIEW OF THE ST-15/CERAMIC ECO-SYSTEMS PUMP

Eco-Sistems ST-15/CERAMIC PUMP ELEMENTS

Reference	Item	Description	Quantity
44015010	1	Distributor body ST-15	1
44015020	2	Upper plate	1
44015030	3	Central body ST-15	1
44015040	4	Distribution control valve slide base	1
44015050	5	Lower plate	1
44015060	6	External cylinder liner	2
44015070	7	Intermediate cap ST-15 (E)	1
44015080	8	Intermediate cap ST-15 (S)	1
44015090	9	Distribution control valve slide ST-15	1
44015100	10	Upper plate fitting	2
44015110	11	Lower deck plate	2
44008110	12	Central valve slide	1
44008130	13	Cylinder	2
44406150	15	Distributor piston	2
44008170	17	Shaft Ø25	1
44008180	18	Shaft washer Ø25	1
44008190	19	Distributor shaft	1
44008200	20	Distributor cylinder	2
44008210	21	Distributor cap	2
44008220	22	Distributor lip seal cap	2
44008240	24	Cylinder cap	2
44008250	25	Piston	2
44008261	26	Distributor valve slide	2
44008271	27	Ceramic base ST-14	2
44405270	30	Spring stopper/guide	6
44406130	31	Springe Ø3x 12 A4	6
43420600	35	Hose Ø6x4	2
43570610	36	Straight R1/8" Gas hose Ø6x4	4
44030300	37	Pressure gauge fitting	1
43710200	38	Sealing cap (with joint) M5	1
43802317	39	Hexagonal screw DIN-931 M6x170	8
43802418	40	Hexagonal screw DIN-931 M8x180	6
43812060	41	Self-blocking nut DIN-985 M6	2
43812100	42	Self-blocking nut DIN-985 M10	2
43821140	43	Plain washer DIN-125 Ø14 A4	2

Reference	Item	Description	Quantity
43822060	44	Plain washer DIN-9021 Ø6 A4	2
43822100	45	Plain washer DIN-9021 Ø10 A4	2
43823060	46	Grower washer Ø6 A4	8
43850532	47	Cylindrical bolt DIN-7 A4 Ø5x28	1
43850510	48	Cylindrical bolt DIN-7 A4 Ø5x10	2
43911440	49	O-ring Ø14x1.78	1
43910540	50	O-ring Ø5x2	3
43911041	51	O-ring Ø10.5x2	2
43911240	52	O-ring Ø12x2	4
43911340	53	O-ring Ø13x2	2
43911540	54	O-ring Ø15x2	2
43912235	55	O-ring Ø21.95x1.78	6
43912350	56	O-ring Ø23x2.5	2
43914050	57	O-ring Ø40x2.5	2
43914550	58	O-ring Ø45x2.5	4
43915750	59	O-ring Ø56.8x2.62	2
43916460	60	O-ring Ø64x3	2
43917560	61	O-ring Ø75x3	4
43918470	62	O-ring Ø84x3.5	1
43942000-B	65	Lip seal Ø20x26x5	1
43942011	66	Lip seal Ø20x30x8	2
43942500	67	Lip seal Ø25x35x10	4
43944000	68	Lip seal Ø40x50x6	2
43946000	69	Lip seal Ø60x70x6	2
43461230	71	Elbow 90° R3/8" Gas hose Ø12	2
43561640	72	Curved barbed fitting R1/2"Hose x16	2
44030320	73	Fitting R1/4"Gas Hose Ø4	2
43180230	74	Pressure gauge	1

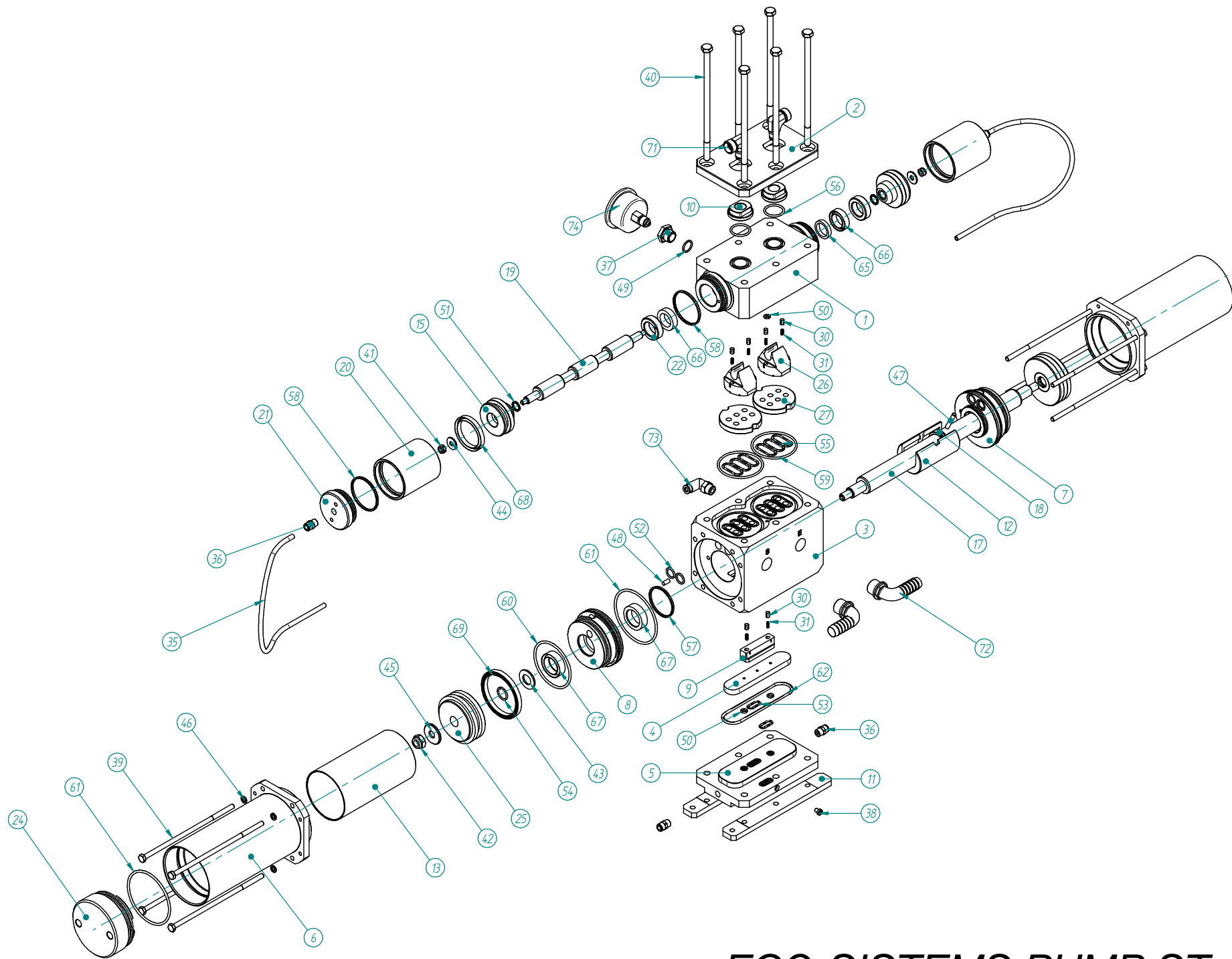

ECO-SYSTEMS PUMP ST-15

CHAPTER IV

FILTERS AND MEMBRANE REPLACEMENT

IV.1. Replacing the filters.

When replacing the filter cartridge make sure you have closed the seawater inlet sea cock valve before unscrewing the bowl filter that enables you to remove the old cartridge and replace it with a new one which has the same specifications: 9 ¾ long, 5 micron calibrated filter. We do not recommend another type of cartridge; it could allow unwanted particles enter the system.

Once replaced, screw the bowl filter back on and re-open the seawater inlet sea cock valve. Warning: use the filter wrench to close it.

To replace the active carbon cartridge, disconnect the boat pressurized fresh water system, open a tab to not leave any residual pressure in the circuit, and replace the active carbon cartridge. Connect the boat pressurized fresh water system again.

IV.2. Membrane Replacement.

Follow these instructions to change the membrane, see diagram (Chapter IV Page 3)

- Before handling the unit, make sure there is no pressure in the circuit. If the pressure gauge indicates there is some, wait until it disappears.
- Dismantle the high pressure hoses, taking care to have two wrenches so as not to loosen the fittings of the end caps (22, 23) located on the vessels (10).
- Remove the stainless steel connector (18) located between both end caps (20, 21), and release the blue Ø8 polyamide tube (19).
- Separate the vessels of their supports (28) and remove the top vessel.
- Remove the end caps (20, 22) to get access to the membranes (24), unscrewing them with the help of a special pivot wrench.
- Once the membranes have been removed, clean the inside of the vessels with chlorine-free water. This will remove dirt, and the water will act as a lubricant for inserting the new membrane.
- Take the new membrane out of its packaging (the packaging is usually an airtight plastic bag).
- Check that the membrane gaskets have no malfunctions, damages or a excessive lack between it and the membrane. It has to be placed with its lips against the water flow direction (see drawing). Lubricate the gasket with water before being placed in the vessel.

- The gasket is located only in one side of the membrane, the outlet side. There is no gasket in the inlet side.
- Check that the membrane permeation tube fits properly into the O-rings inside the sealing caps (20, 22).
- Place the membrane and screw the end caps previously removed, with the pivot wrench.
- Repeat with the lower vessel.
- Reassemble the vessels on their supports (28).
- Adjust properly the stainless steel connector (18) and the blue Ø8 polyamide tube (19) between both vessels.
- Reconnect the high pressure hoses, making sure the fitting nuts are well tight. Connect the fresh water outlet.

NOTE:

De location of the gasket on the membrane, is different than in the 2540 Standard model, it is placed on the side marked as (OUTLET) with its lips against the water flow direction (FLOW).

Before restarting the unit, make sure the valve (11) (see drawing in Chapter I, Page 1) is in the “*PRUEBA/TEST*” position and proceed as indicated in Chapter I section 5 **FIRST START-UP** following all the steps set out in that section in detail.

WARNING.- The membrane may have air inside and it needs a few minutes to be completely taken out.

